



KNAUF



BUILT ON EXPERIENCE

Knauf Exterior Wall with AQUAPANEL® Technology

AQUAPANEL®

THE DESIGN AND CONSTRUCTION LANDSCAPE IS CHANGING





There's an increasing demand to build faster, more efficiently and cost-effectively. There's a global call for more imaginative and sustainable designs. And there's a revolution in materials and construction techniques, opening up a new world of possibilities.

Architects are at the forefront of these changes. Driven by their vision and experience, the built environment is changing for the better, with more ambitious ideas, inspirational designs and beautiful spaces where people want to live and work.

For over 80 years, Knauf has been partnering architects in shaping this new landscape.

Continually pioneering new products, services and solutions in drywall construction, we push the boundaries of what's possible, opening the door to bolder design and better buildings. This is our expertise. Combined with the experience and talent of architects, we're changing the way the world builds – more creatively, more efficiently, more sustainably.

CONTENTS

KNAUF EXTERIOR WALL – THE ADVANTAGES

Introduction: built on experience	4
Dedicated system solutions	5
Creative designs	6
Fast and easy construction	10
Economic advantages	12
Environmental sustainability	14
Building engineering physics	18
Support and services	20
AQUAPANEL® Cement Board Outdoor	22

KNAUF EXTERIOR WALL – THE SOLUTIONS

Overview	24
Double stud systems	26
Single stud systems	42
Rear-ventilated rainscreen facades	50
Timber frame construction	54
Steel frame construction	56

KNAUF EXTERIOR WALL – THE PRODUCTS

Product range	58
Product handling	70
Further information	71

BUILT ON EXPERIENCE

In a fast-changing world, Knauf Exterior Wall with AQUAPANEL® Technology delivers creativity, certainty and complete peace of mind whatever the building type - from offices and high-rise residential accommodation through to hospitals and stadia.

Challenging the dominance of brick and block, Knauf Exterior Wall is helping shape some of the world's most ambitious and breath-taking projects, including the Allianz Arena (Munich), the Chinese Opera House (Xiqu Centre) in Hong Kong, the Eagle in Flight (Tirana) and the 'A House' in Yongin (South Korea).

Knauf Exterior Wall doesn't just build on the skills and experience of architects. It helps

them step away from traditional thinking and conventional construction methods - and to build inspirational spaces for the world to enjoy.

As a complete and lightweight drywall system, it sets a new standard for strength, versatility and performance. It can be shaped and curved into endlessly imaginative designs. It can carry a wide range of finishes - from paint, render

and tiles through to decorative cladding. Its lightweight properties mean it can be used to create floor extensions and facade systems which repurpose old buildings and extend their service life.

It's a truly sustainable and future-proofed solution, helping create energy efficient buildings. It's also easy to work with, promoting safe and speedy construction.



DEDICATED SYSTEM SOLUTIONS

Knauf Exterior Wall comes in two basic types: drywall, or as a rear-ventilated rainscreen facade. It therefore offers an extremely flexible and adaptable solution which can accommodate an impressive range of designs, opening up new architectural possibilities and helping to turn vision into reality, whether it's being used to create commercial or high-rise residential buildings, or sports arenas or healthcare establishments. Truly, we are changing the way the world builds.

Knauf Exterior Wall – drywall solution

Drywall systems are available as single stud or double stud solutions with a variety of creative design options. And although it is most commonly used in skeleton constructions comprising reinforced concrete, drywall is also suitable for timber (see page 54) or lightweight steel-frame constructions (see page 56).



Knauf Exterior Wall – rear-ventilated rainscreen facade

With rainscreen facades for use above solid substructures such as brick or concrete, thermal insulation is separated from the weather protection materials ensuring a constant flow of air in the ventilated space to remove moisture from the building and to optimise indoor climate. Even if the facade is damaged, the insulation remains intact.

CREATIVE FREEDOM WITHOUT LIMITS

Architects and specifiers worldwide are discovering the liberating potential of Knauf Exterior Wall with AQUAPANEL® Technology. Strong, light and easy to shape into inspirational designs, the system is also able to accommodate a huge range of finishes to beautiful effect. And thanks to its easy adaptability and simple integration of building technology, Knauf Exterior Wall always remains flexible against any usage – or weather-related influences.





New design possibilities for curved walls

With a bending radius of 3 metres (full board) and 1 m (300 mm strips), AQUAPANEL® Cement Board Outdoor allows designers to introduce a variety of curved shapes and creative designs, including domes and arches. Moreover, by using double studs, it's possible to create different interiors and exteriors: for example, a wall that's concave on the outside, and convex on the inside.

Arrangement of AQUAPANEL® Cement Board Outdoor with different radius

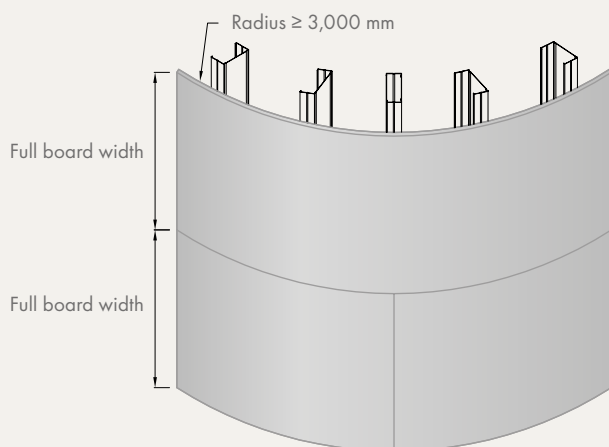

Assembly with full board size panels for radius $\geq 3,000$ mm

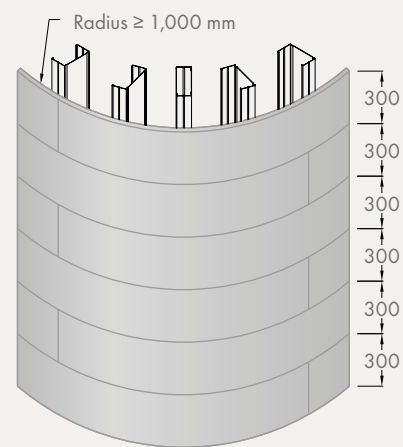

Assembly with 300 mm width panels for radius $\geq 1,000$ mm

Stunning surfaces and finishing options

Compatible with an extensive range of surface finishes, from paint and renders, through to adhered materials like clinker bricks, tiles or glass elements, Knauf Exterior Wall solutions offer unlimited scope for creative expression. Even a variety of cladding systems can be realised, resulting in very thin ventilated constructions, because the required insulation is already integrated inside the drywall.

Renders



Broom finish

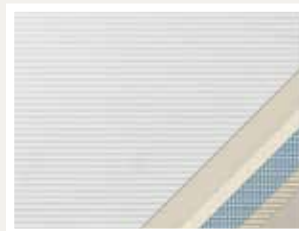

Combing technique



Concrete look



Fine sponged render



Groove render



Modelling render



Paint finish



Pebble dash

Adhered materials



Ceramic facing bricks



Clinker bricks



Glass elements

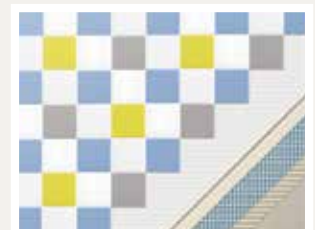

Mosaic tiles

Ventilated facades on drywall constructions



Aluminium panels



Ceramic tiles



Glass panels



Granite plates

Future-proofed and adaptable designs

The pressure on space, the protection of green land, the cost of materials and the demand for sustainability are all reasons why building redevelopment will increasingly gain importance in the future. And already now, architects are embracing the creative challenges of re-imagining and repurposing existing buildings to breathe new life into old stock. With its lightweight properties Knauf Exterior Wall is at the forefront of this movement.



Flotted render



Variegated stone wall render



Sandstein design



High-pressure compact laminate

Simple to remove and reconfigure, and giving easy access to electrics, pipework and trunking, Knauf Exterior Wall allows modifications and reutilisations to be carried out quickly and efficiently, helping change the look of buildings, as well as their function. This also includes measures during running operation of the building: for example, changing the layout of hospitals to accommodate changing need. Whether it's repair, modification, more energy-efficient renovation or creative remodelling, Knauf Exterior Wall provides a future-proofed and adaptable solution.

Multifunctional and integrative compositions

Depending on the construction task and location, increasing demands are placed on building technology. It is responsible, for example, for measuring weather-related, daily and seasonal conditions on the outside and for harmonising ventilation, lighting and heating technology in a way that guarantees a comfortable environment on the inside. Such climatic and energy optimisation is often accompanied by technical solutions that normally take up space in the interior of the building.

With the help of Knauf Exterior Wall, such solutions can be integrated into the building envelope faster, more flexibly and more easily compared to solid construction methods. Wall openings or core hole drillings through the outer wall can be omitted and electrical connections are easy to install even in the event of a retrofitted installation. In this way – for example, due to the installation of decentralised heating and ventilation equipment inside Knauf Exterior Wall – the usable space in the interior is increased and construction costs are saved by reducing the floor heights. This is because suspended ceilings to accommodate an air distribution system are no longer required.



FASTER, EASIER, MORE EFFICIENTLY

The installation of Knauf Exterior Wall is fast and efficient. Its components are light and easy to handle and due to the just in time window installation and the fast closing of the building envelope, the construction is largely weather-independent and interior works can begin significantly earlier than with conventional building methods.

Simplified installation

Knauf Exterior Walls with AQUAPANEL® Technology are easy to use. All drywall and facade works – exterior, interior and finishing – can be carried out by a single trade, meaning fewer hands and less risk as well as a streamlined construction process. Only the cabling and pipework inside the interior stud frame as well as window and windowsill installation require the involvement of additional parties.

Easier handling

The core component of Knauf Exterior Wall – AQUAPANEL® Cement Board Outdoor – is a lightweight board, making it much easier to handle. No pre-drilling is required, while a simple ‘score and snap’ technique means it can be cut quickly and efficiently. It also has a bending radius of up to 1 m in a dry state, further simplifying construction.

Similarly, Knauf’s glass mineral wool with ECOSE® Technology delivers significant advantages in handling. As well as being odourless and generating significantly less dust, over 90% of professional installers state that glass mineral wool with ECOSE® Technology is softer and less itchy than conventional mineral wool. A majority of installers also say it’s easier to cut.



Digression: creating much needed living space

In times of increasing urbanisation worldwide, and at the same time scarce living space in the cities, calls for fast residential construction are becoming louder and louder. However, traditional solid construction methods do not seem to offer any solutions for the creation of timely and affordable housing for broad sections of the population. Many answers are therefore aimed at modular construction, which can be carried out quickly and weather-independently due to prefabrication in the factory. Mass production makes these offers affordable, but – depending on the supplier – may also entail compromises in terms of individuality.

In addition, some municipalities and housing associations see a challenge in the compatibility at the modules’ intersections (e.g. cable and pipe installation or joint treatment) and

against the backdrop of resource efficiency, modular construction is not necessarily the first choice. Because, to withstand the high loads during transport, steel needs to be installed – more than necessary if assembled on site.

Here Knauf Exterior Wall forms a middle ground between usual solid construction methods on site and the modular design in the factory. Knauf Exterior Wall, like solid construction, can be designed individually, but is less fraught with risk due to fewer interfaces between individual trades. At the same time, like modular construction, it is efficient and largely weather-independent, and additionally offers compatibility due to the lack of intersection issues. Knauf Exterior Wall thus combines the advantages of both construction methods – modular and solid.

Accelerated construction

The building envelope can be closed immediately after the joint treatment of the boards, significantly earlier than with conventional methods such as brick and block. (Once jointed, the boards can also be left for up to 6 months, providing added peace of mind). As a result, interior works (including screeding and the installation of stud frames, vapour barriers, lining and insulation) can progress simultaneously with exterior finishing, resulting in a more efficient construction.

Working to precise plans and dimensions, manufacturers can build windows in advance and transport them to the site, ready for immediate installation. This adds reassurance to project delivery deadlines and significantly contributes to accelerated construction and weather independence compared to traditional ways of construction. In masonry variants, such as aerated concrete or sand lime brick, if the windows are not installed in the insulation layer, the openings must first be measured after erection of the exterior wall. Unlike Knauf Exterior Wall, this is a disadvantage which brings considerable time delays.

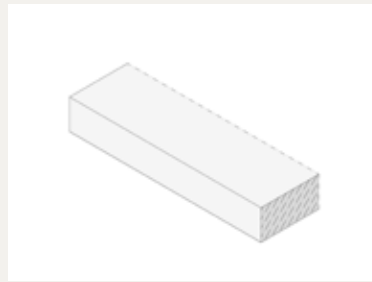

1. Install the scaffold

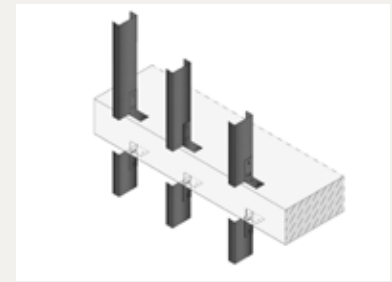

2. Install exterior stud frame

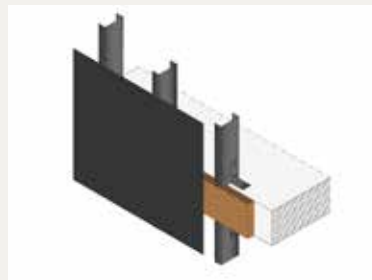

3. Insulate floor front and temporarily bond water barrier to the studs

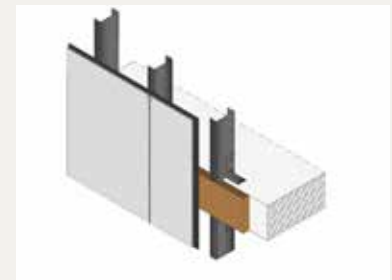

4. Install ACB outdoor

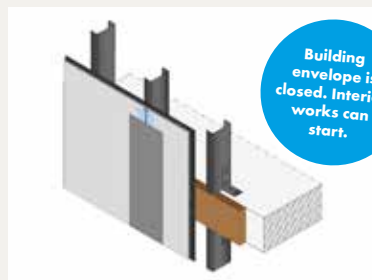

5. Joint treatment

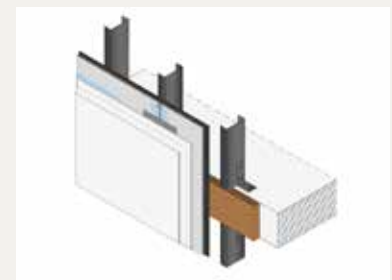

6. Apply base coat and finishing

Solid construction/traditional construction – example: office building 3,000 m² area

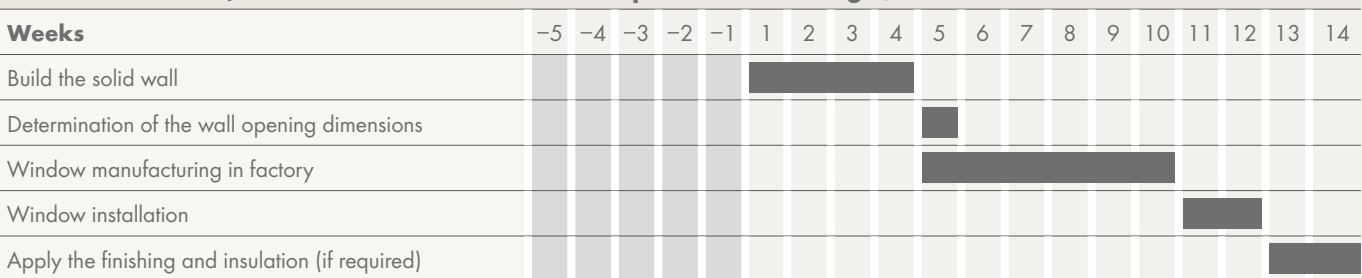

Knauf Exterior Wall – example: office building 3,000 m² area

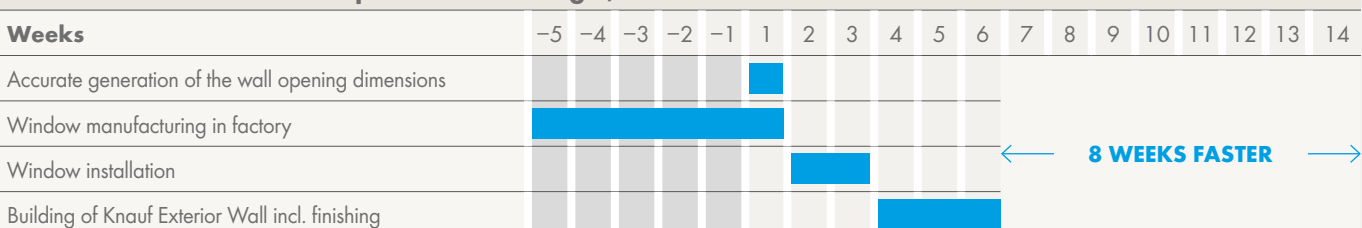

FASTER PAYBACK AND A HIGHER RETURN ON INVESTMENT

The lightweight nature of Knauf Exterior Wall doesn't just help deliver efficient and economical builds, it delivers significant financial benefits too, both in terms of construction costs and rental or resale value.



Lower construction costs

Because Knauf Exterior Wall with AQUAPANEL® Technology is a lightweight solution, there is significantly less bearing load in both primary construction and foundation works. How significant the weight difference between traditional construction methods and Knauf Exterior Wall can be, is shown in the graphs at the bottom of this page. As a result, the building design and its construction can be executed much more cost-effectively.

Weight for weight, Knauf Exterior Wall solutions also cost less to transport than traditional building materials such as brick, while the speed of installation reduces the extended need for scaffolding, helping cut rental costs. Equally, the use of drywall solutions eliminates water waste, while a faster drying time minimises the amount of energy needed to dry out the construction. These advantages drive cost benefit into the project right from the start.

Minimum weight savings due to the usage of Knauf Exterior Wall compared with traditional solutions*

These figures show the minimum difference in weight per square metre of an undisturbed wall based on the six drywall solutions, shown in this brochure (see pages 26-49).

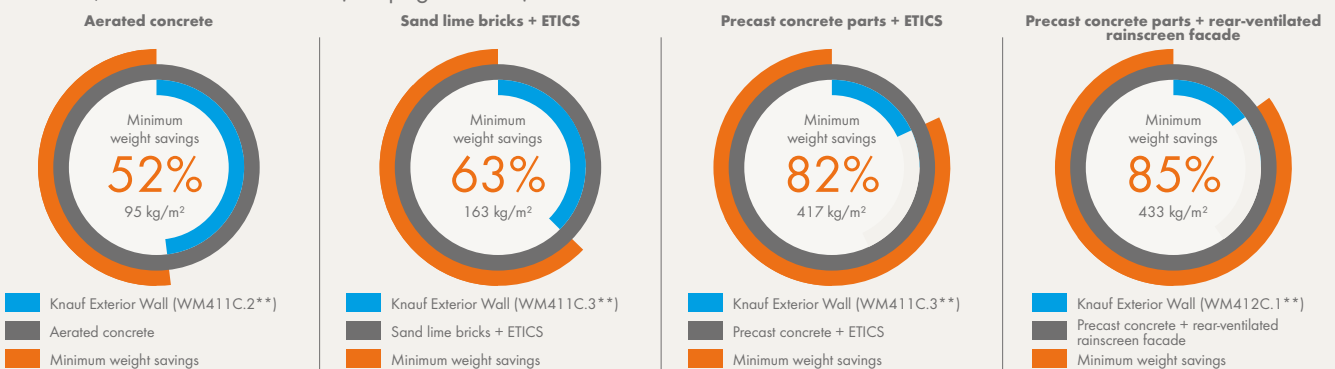

*Figures are based on a study by Prof. Dr. Bert Bielefeld of the University of Siegen, Germany. All measurements use comparable U-values.

** see page 24-25 for a system overview

Increased sale and rental value

With Knauf Exterior Wall, it is possible to achieve the same thermal performance as brick and block with a thinner wall thickness, meaning that more internal floor space is available for sale or for rent. The graphs at the bottom of this page show how much of the area occupied by the exterior wall in traditional ways of construction can be converted into usable, productive space by using Knauf Exterior Wall. Equally, speedy construction means that a sale – or rental return – can be achieved more quickly than with traditional construction methods. Both factors combine to ensure a faster and higher return on investment.



Minimum difference in wall thickness of Knauf Exterior Wall compared with traditional solutions*

These figures show the minimum difference in wall thickness based on the six drywall solutions, shown in this brochure (pages 26-49).

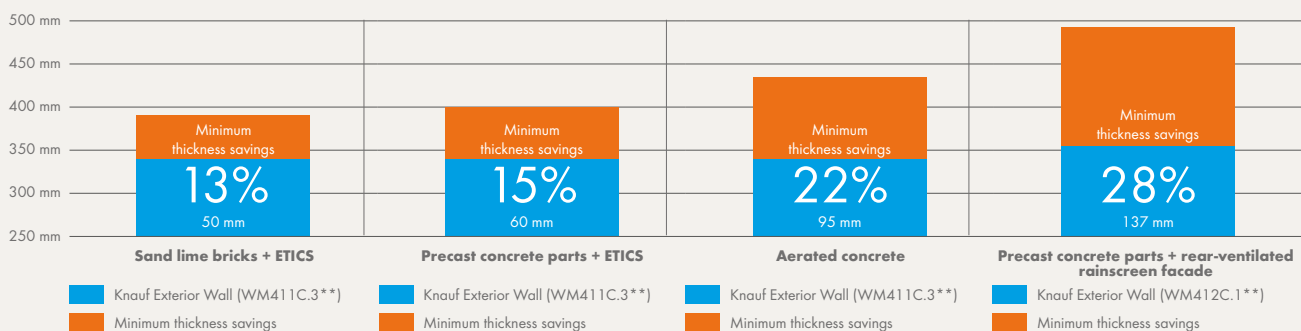

*Figures are based on a study by Prof. Dr. Bert Bielefeld of the University of Siegen, Germany. All measurements use comparable U-values.

** see page 24-25 for a system overview

OPTIMUM DESIGN, MINIMUM IMPACT

In today's construction environment, there is a drive to reduce the impact of the building on human health and the natural environment. This must be considered at every stage of the process, from planning and design through to construction, use, renovation and demolition. There are various ways this can be achieved, and Knauf Exterior Wall solutions offer strong capabilities in each case.



Energy efficiency and CO₂ reduction

Energy is used both in the production, transportation and installation of building materials (the 'embodied' energy), as well as during habitation and use (the 'operating' energy).

Embodied energy

This represents up to 30% of the overall life-cycle energy consumption of a building and is therefore a significant factor. The exact percentage varies based on factors including the age of building, the local climate and the exact nature of materials used. Historically, this percentage has been lower. However, the intensifying focus on minimising operational emissions – e.g. by driving efficiency improvements in heating and cooling – has meant both a relative increase in embodied energy, and in its importance as a measure.

Many of the products within Knauf Exterior Wall with AQUAPANEL® Technology possess an Environmental Product Declaration (EPD) as per ISO 14025 and EN 15804. In addition to referencing environmental impact and waste categories, these EPDs at least provide a product life cycle assessment from cradle-to-gate, including the energy resources needed to

supply and transport raw materials and to manufacture the end product.

As a complete system, Knauf Exterior Wall has a 50% less primary energy requirement during manufacture than conventional brickwork construction. Equally, CO₂ output in material production for a Knauf Exterior Wall is 30% lower than brick and block construction. As a specific example, mineral wool with ECOSE® Technology from Knauf Insulation uses a formaldehyde free binding agent, reducing energy demand during manufacturing.

Additionally, because of its lightweight properties, Knauf Exterior Wall uses less energy and generates less CO₂ during transportation, while – because it is a drywall construction – the drying time of the building and therefore the energy required are significantly reduced during the construction phase.

Operating energy

Buildings with a high-performance envelope in a cold climate require just 20% to 30% of the energy required to heat the current average building (source: the Organisation of Economic Co-operation and Development – OECD). The insulation within the walls is a critical factor, and Knauf Exterior Wall has many advantages in this respect – not least superior thermal insulation compared with traditional constructions of an equal thickness. This can be further enhanced by minimising thermal bridges (see page 19). These advantages are at their biggest with

the initial layer of insulation – especially in developing countries where insulation is often not being installed – but can also be significant in developed countries. This is especially the case in renovations of poorly insulated stone, masonry or concrete constructions, where Knauf's rear-ventilated rainscreen facade with insulation (see page 50) offers a smart and effective solution. The ability to install varying thicknesses of mineral wool in that system, means that the desired energy standard can be reached, even in the most demanding situations.

Materials efficiency and waste reduction

Efficient building materials include products that are reusable, renewable, and/or recyclable. The reuse and recycling of these materials require that buildings at the end of their useful life are not demolished and hauled to landfills. 'Deconstruction' is a method of harvesting and reclaiming useful building materials. Selective demounting and separation of Knauf Exterior Wall with AQUAPANEL® Technology can be carried out easily, reducing the volume

of waste while increasing the potential for recycling.

Simply re-imagining a building and extending its useful life also reduces waste. The adaptability of Knauf Exterior Wall (see page 9) facilitates modifications and reutilisations, even while the building is in use. Renovations with rear-ventilated facade systems guarantee continued use without being forced to make compromises in design or energy-

efficiency. And once installed, a service life of approximately 50 years can be achieved (according to Environmental System Declaration).

Waste arising during production of AQUAPANEL® Cement Board Outdoor is fed back into the production process. The amount of recyclable materials in the composition of AQUAPANEL® Cement Board Outdoor is approximately 5-10% by mass.





Protecting occupant health

In LEED standards, the Indoor Environmental Quality (IEQ) sets out to measure and improve the well-being and comfort of building occupants using five key categories – one of which is indoor air quality (IAQ). Here, the focus is on minimising the effects of air impurities – including volatile organic compounds (VOC) and other microbial contaminants – which are present in the majority of building materials and maintenance products, and which have the potential to negatively impact on occupant health and productivity. Choosing zero or low VOC emission materials and finishing products – such as those built in Knauf Exterior Wall – improves both the building's IAQ and the comfort of its occupants.

Most of the products of Knauf Exterior Wall are classified A+ according to French VOC regulation. As an example, the ECOSE® Technology from Knauf Insulation enables the production of natural mineral wool insulation materials bonded with a bio-based technology free from formaldehyde, phenols, acrylics and with no artificial colours, bleach or added dyes. These

products passed a VOC emission chamber test, where the sum of VOC measured was below the limit values of 1,000 µg/m³ after 3 days and 100 µg/m³ after 28 days. The products were awarded with the Eurofins Indoor Air Comfort Gold Certificate.

The accumulation of moisture and the knock-on effects of damp – including mould, viruses and bacteria – are also contributing factors to poor IAQ. Using water and mould resistant products helps to minimise or eliminate these issues.

To achieve reliable moisture protection, Knauf Exterior Wall has a layered structure with a carefully designed sequence of vapour barring and breathable materials. In an unfavourable climate, this helps to diffuse condensate safely to the ambient air. To protect the insulation, the water and windproof AQUAPANEL® Water Barrier is installed behind the AQUAPANEL® Cement Board Outdoor, while to avoid condensate formation inside the wall, a vapour barrier is installed behind the interior lining.

Quality certifications

Company:

- › ISO 9001

Systems:

- › Environmental System Declaration

Products:

- › Declaration of Performance
- › ETA-07/0173
- › LEED Confirmation
- › Certificate of Building Biology
- › Environmental Product Declarations
- › Safety Against Ball Throwing
- › Blue Angel (Insulation)
- › Eurofins Indoor Air Comfort Gold Certificate (Insulation)



Click or scan to get access to certificates

BUILDING ENGINEERING PHYSICS – A CERTAIN SOLUTION

The defining quality of Knauf Exterior Wall solutions is the ability to prevent water from entering the construction. Combined with moisture protection, thermal and acoustic performance and effective resistance to both fire and seismic activity, Knauf Exterior Wall with AQUAPANEL® Technology allows you to create the buildings you want, with the attributes you demand and the quality assurance you need.



Moisture protection

Knauf Exterior Wall solutions feature a layer design which combines a sequence of vapour barring and breathable materials to enable moisture and condensate within the construction to be safely released. The result is reliable protection in even the most unfavourable climates.

Corrosion protection

The Knauf Exterior Wall consists of a lightweight steel construction including fastener, connecting and anchoring materials. The steel components are to be protected against corrosion. The minimum corrosion protection category to be chosen is C3-high according to EN ISO 12944 (urban and industrial atmospheres with moderate air pollution) to ensure the serviceability and longevity of the Knauf Exterior Wall of 50 years. For higher requirements and the corrosion protection category to be chosen, a detailed analysis of the object-related atmosphere has to be carried out. Generally, the category of corrosion protection has to be determined by the planner on an object-related basis.

Fire protection

All components within Knauf Exterior Wall are non-combustible, with the exception of the membranes which dissipate quickly without causing damage. By exchanging or adding components, Knauf Exterior Wall can meet a variety of fire safety requirements. For example, fire resistance class EI30 of an undisturbed wall construction can be achieved by lining the interior stud frame with two gypsum boards (for example see system on page 30).

Sound protection

Because of its construction and sequence of layers, Knauf Exterior Wall creates a spring-mass system which helps maximise sound reduction. Window installations and other penetrations of the wall can influence the sound protection of the exterior wall and have to be considered object-wise.

Thermal insulation

Knauf Exterior Wall provides superior thermal insulation compared with traditional constructions of an equal thickness. And the thermal performance of each Knauf Exterior Wall can be further enhanced with various measures, each helping to minimise the impact of thermal bridging.

Examples include using:

- › A second insulation layer, such as ETICS
- › A double stud system instead of a single stud
- › Intermediate insulation between the stud frames in a double stud system
- › Offset/staggered profiles
- › Ventilated construction or a construction in front of floors to minimise thermal bridges between Knauf Exterior Wall and the concrete slabs

With respect to thermal insulation, the construction related advantages of the rear-ventilated rainscreen facade (see page 50) are the heat insulation and the good room climate conditions in the summer. The discharge of hot air over the ventilation gap prevents a potential heat accumulation or a heat up between facade and insulation. Furthermore the exterior wall warms up to a lesser extent and more slowly than with direct contact with solar radiation. That way the temperature inside the building remains comfortable in the summer, the room climate is less vulnerable to variations in outdoor temperature, and the energy demand for cooling is reduced.

Earthquake safety

During seismic activity, Knauf Exterior Wall experiences a lower risk of failure than traditional construction materials, thanks to its ductility and positive deformation behaviour. Moreover, in the event of actual failure, its lightweight properties are less potentially damaging to the surrounding area. Compared with most other building

types, Knauf Exterior Wall is also easier to repair and rebuild, making it ideal for use in earthquake zones.

Expansion joints

Expansion joints have to be provided at a distance of ≤ 15 m, in order to allow weather-related expansion and shrinkage. Building separation joints and expansion joints in the primary construction have to be incorporated into the facade. Some facade geometries such as complex surfaces and facades that are subject to increased stress may require additional expansion joints.



BRINGING EXCELLENCE AND EXPERTISE TO YOUR PROJECT



Knauf Exterior Wall encapsulates versatile components and features - but, more importantly, it embodies the expertise of our pioneering past. Because of this, we're able to help shape a better present and future. Our whole focus is on supporting our partners and customers, giving them the inspiration and solutions they need to create better buildings.

Established in 1932, Knauf is a global group employing over 27,000 people across 86 countries. Supported with an extensive distributor network, we deliver an exceptional local service across all territories - and all from one single source. A key part of this group - and of Knauf's Exterior Wall with AQUAPANEL® Technology - Knauf AQUAPANEL is based in Germany. Since 2002, Knauf AQUAPANEL has pioneered drywalling solutions and technology and applied its expertise to help create certainty in a changing world.

AQUAPANEL® is the home of the Knauf Dry Exterior Wall Competence Centre

Knauf AQUAPANEL is also the home of the Knauf Dry Exterior Wall Competence Centre. Sitting at the heart of our innovation and technical expertise, this centre acts

as a pivotal resource, gathering insight and best practice and offering advice and technical support at every stage of the process - from design, specification and planning through to installation and beyond, ensuring that the full benefits of Knauf Exterior Wall solutions are available to our customers.





Our support includes:

- › Local expertise delivered via country-based Specification Managers (with the back-up of an International Technical Support team)
- › Project-related system recommendations including static pre-dimensioning, physical analyses, U-Value calculations and hygrothermal simulation
- › Site visits and support, via an experienced team of Application Engineers
- › Assistance with the certification of products and systems, including approval tests and building law examinations
- › The supply of samples, mock-ups or demonstrations to aid decision-making
- › Wide range of technical documentation including consumption tables, installation guides, leaflets and CAD Files
- › Wide range of technical and practical training, available locally or at our International Training Centre in Dortmund
- › ISO 9001 certified, ensuring Quality Control and high standards of service

AQUAPANEL® CEMENT BOARD OUTDOOR

Exceptional weatherproofing, outstanding benefits.

Knauf Exterior Wall with AQUAPANEL® Technology comprises comprehensive system solutions, made possible by a core product at the heart of each system – AQUAPANEL® Cement Board Outdoor. This key component is a premium product offering unrivalled performance in wet and humid conditions, helping to protect buildings quickly, effectively and permanently. Manufactured from aggregated Portland cement, AQUAPANEL® Cement Board Outdoor features coated glass fibre mesh in the back and front surfaces for added strength. The ends are square cut, and the edges reinforced with a smooth finish (EasyEdge™).



Performance

- › 100% water-resistant – dimensional stability
- › Mould and mildew resistant
- › Freeze-thaw cycle proven
- › Non-combustible (A1) – complies with European standards
- › Robust and reliable, safe and hygienic material

Installation

- › Lightweight cement board – less effort in handling
- › Easy to cut using a simple score and snap technique
- › No pre-drilling required
- › Bending radius of 3 m at full board size, and 1 m with 300 mm wide strips

Finishing

The AQUAPANEL® portfolio includes mineral finish, dispersion plaster, and silicon synthetic resin plaster. Moreover it is compatible with...

- › Paint
- › Brick slips
- › Tiles
- › Claddings (e.g. aluminium, granite stone, glass and many more)

Physical properties			
Length (mm)	1,200	900	800
	2,400	2,000	2,000
	1,250	2,400	2,500
	2,500	2,500	
		2,800	
	3,000		
Width (mm)	900	1,200	1,250
Depth (mm)	12.5		
Min. bending radius for 900/1,200/1,250 mm wide board	3		
Min. bending radius for 300 mm wide strip	1		
Weight (kg/m ²)	approx. 16		
Dry bulk density (kg/m ³) according to EN 12467	approx. 1,150		
Bending strength (N/mm ²) according to EN 12467	> 7		
pH-value	12		
Thermal conductivity (W/mK) according to EN ISO 10456	0.35		
Thermal expansion (10 ⁻⁶ K ⁻¹)	7		
Water vapour diffusion coefficient (-) according to EN ISO 12572	66		
Building material class according to EN 13501	A1 non-combustible		









KNAUF EXTERIOR WALL







– THE SOLUTIONS

Available in a multitude of modular, dedicated systems, Knauf Exterior Wall with AQUAPANEL® Technology can be quickly and easily configured to meet a range of design challenges in the planning phase - from complex physical requirements to commercial or economic considerations. The examples on the following pages represent just a small sample of possible permutations.

Knauf Exterior Wall with AQUAPANEL® Technology comes in two basic types: as drywall in skeleton constructions (e.g. reinforced concrete) or as a rear-ventilated rainscreen facade for use above solid substructures such as brick or concrete. In both cases the primary construction is carrying the structural load, while the lightweight Knauf Exterior Wall solutions carry their own dead weight and the wind loads.

Double stud systems				Single stud systems	
<p>Knauf's double stud systems comprise an interior stud frame constructed as a shaft wall, providing airtightness, protection against falling and fire resistance from the inside. Insulation is placed inside the shaft wall, while the space between the exterior and interior stud frames can also be insulated with glass wool, according to requirements. The exterior stud frame provides weather protection and transfers wind loads into the primary structure. It can be installed in between floors and in front of floors using L metal profiles.</p>				<p>Where there are low or no special requirements for thermal and sound insulation, Knauf's single stud system is an ideal solution. Lightweight and with a thin profile, it is quick and easy to install. Extra insulation can be added by attaching an external thermal insulation composite system (ETICS) to the front of AQUAPANEL® Cement Board Outdoor.</p>	
WM411C.1	WM411C.2	WM411C.3	WM412C.1	WM111C.1	WM111C.2
					
<ul style="list-style-type: none"> › Double stud › Installed between floors 	<ul style="list-style-type: none"> › Double stud › Installed in front of floors 	<ul style="list-style-type: none"> › Double stud › KEW profile › Installed between floors 	<ul style="list-style-type: none"> › Double stud › KEW profile › 3rd party rainscreen facade › Installed between floors 	<ul style="list-style-type: none"> › Single stud 	<ul style="list-style-type: none"> › Single stud › KEW profile › ETICS
See pages 26-29	See pages 30-33	See pages 34-37	See pages 38-41	See pages 42-45	See pages 46-49



Rear-ventilated rainscreen facades		Timber frame constructions		Steel constructions (Cocoon)	
<p>With classic rear-ventilated rainscreen facades in front of massive constructions such as brick or concrete, thermal insulation is separated from the weather protection materials ensuring a constant flow of air in the ventilated space to remove moisture from the building. On projects where insulation is not required – typically during some purely cosmetic renovations – Knauf Exterior Wall can be used to create very thin facade constructions.</p>		<p>Although it is most commonly used in skeleton constructions made of reinforced concrete, Knauf Exterior Wall is also suitable for timber constructions.</p>		<p>The Cocoon solutions enable lightweight load-bearing steel-frame constructions or prefabricated facade modules which can be delivered just in time for final assembly at the construction site.</p>	
WL132C.1	WL132C.2	WT121C.1	WT222C.1	WM422C.1	WM122C.1
					
<ul style="list-style-type: none"> › Rear-ventilated rainscreen facade › With thermal insulation 	<ul style="list-style-type: none"> › Rear-ventilated rainscreen facade › Without thermal insulation 	<ul style="list-style-type: none"> › Timber frame construction › Single stud 	<ul style="list-style-type: none"> › Timber frame construction › Single stud › Interior installation level › Ventilated 	<ul style="list-style-type: none"> › Cocoon › Prefabricated facade modules 	<ul style="list-style-type: none"> › Cocoon › Lightweight load-bearing steel-frame construction
See pages 50-51	See pages 52-53	See page 54	See page 55	See page 56	See page 57



WM411C.1

Double stud, installed between floors.

The WM411C.1 is a double metal stud system splitting up the performance characteristics of Knauf Exterior Wall onto two stud frames. The interior stud frame is constructed as a shaft wall, providing airtightness and protection against falling. The exterior stud frame is completed with intermediate cladding and provides weather protection and transfers wind loads into the primary structure. The basic system is constructed as a classical facade infill between the columns and floors of the skeleton construction and the space between the two metal stud frames is left blank resulting in a 20 mm air layer.

Click or scan to get more information about this system



Residenza Degli Orti | Milan, Italy



Landmark Tower | Bremen, Germany



Offices Kasanova | Agrate Brianza, Italy



Residenza Degli Orti | Milan, Italy

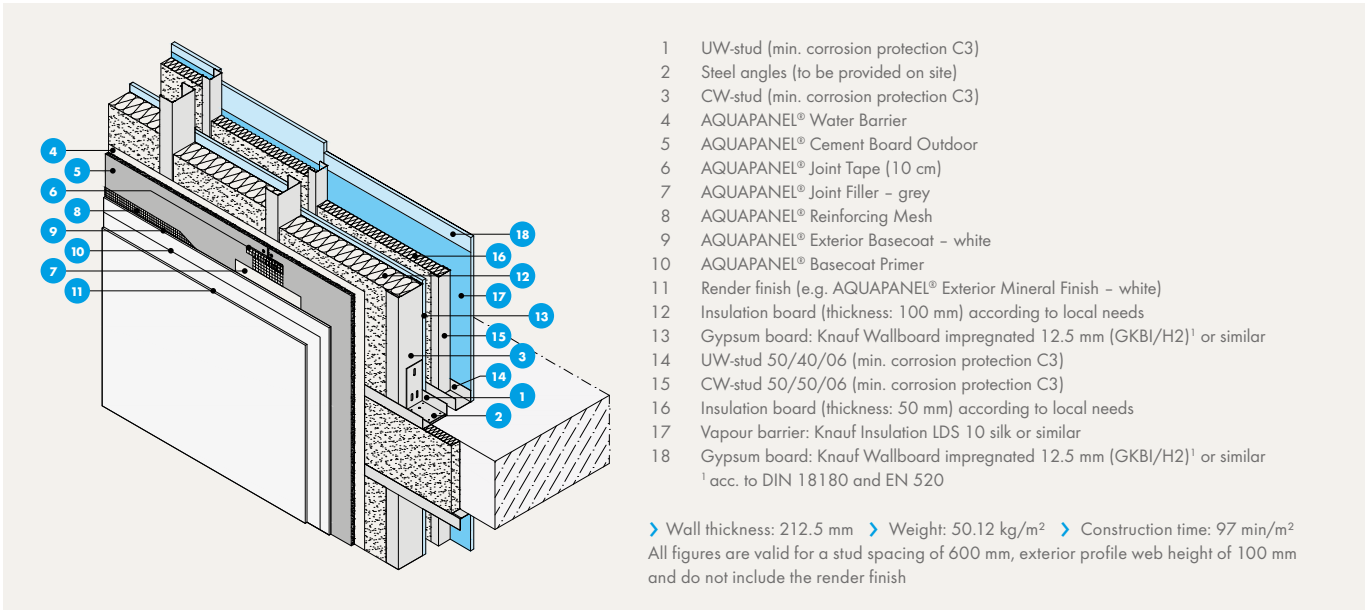

Economic advantages (example: floor extension)

Building perimeter: 58 m
 Floor height: 3 m
 Exterior wall surface per floor: 174 m²
 Number of floors: 1
 Wall opening share: 25%
 Opening surface: 43.50 m²
 Net exterior wall surface: 130.50 m²

- Thickness: aerated concrete
- Thickness: WM411C.1
- Space gain

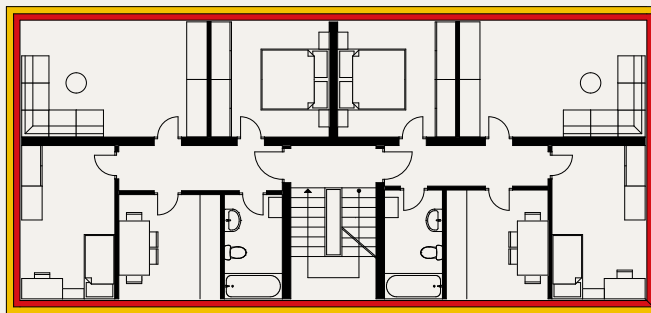

19.20 m

9.08 m

Cost-influencing factors*

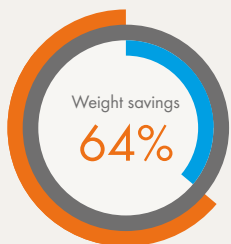

9 tons WM411C.1 26 tons Aerated concrete 16 tons Weight savings

Based on a specific intended use and location of a building, the dead weight is the most important factor of the total loads, which can be influenced by planning. Basically, lower loads enable a leaner structure and thus significant cost savings.

The calculation of explicit cost saving amounts for load-bearing walls and ceilings as well as foundations achieved by the weight reduction when using Knauf Exterior Wall is generically not possible, since this is always to be calculated project specifically on the basis of floor plan geometries, spans and the load-bearing capacity of the building ground.

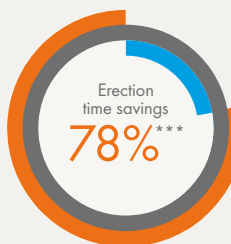

13 days WM411C.1 58 days Aerated concrete 45 days Erection time savings

With a longer production time, considerable costs for personnel employment are involved. Additionally, a longer building process means a longer supply of building site facilities, where costs should be minimised. The efficient construction of Knauf Exterior Wall as well as the shorter drying times and the significantly lower weather dependency compared to massive constructions offer a considerable cost reduction potential and entails much less risk in the planning of the construction process.

Revenue-influencing factors*



Space gain when using WM411C.1 compared to aerated concrete



Additional income through rental (in €/year)**

By using Knauf Exterior Wall more space can be realised inside the building with a comparable thermal insulation value. Consequently, rentable space and resulting rental income are larger. For landlords and investors, the best possible use of the land area plays an important role. By using Knauf Exterior Wall, this area efficiency and land utilisation are significantly improved.

*Figures are based on a study by Prof. Dr. Bert Bielefeld of the University of Siegen, Germany. All measurements use comparable U-values.

**Rental income based (in €/m² per month): €10.00

***The time saved due to the immediate window installation is taken into account (see page 11)

Preliminary design acc. to EN 1993-1-3 for CW 150/50/06

	span (m); wall heights								
Wind load w_e (kN/m ²)	2.4	2.6	2.8	3.0	3.2	3.4	3.6	3.8	4.0
0.4									
0.5									
0.6									●
0.7								●	●
0.8							●	●	●
0.9							●	●	●
1.0					●	●	●	●	●
1.1				●	●	●	●	●	●
1.2				●	●	●	●	●	●
1.3			●	●	●	●	●	●	
1.4			●	●	●	●	●	●	
1.5		●	●	●	●	●	●		
1.6		●	●	●	●	●			
1.7		●	●	●	●	●			
1.8	●	●	●	●	●				
1.9	●	●	●	●	●				
2.0	●	●	●	●	●				
2.1	●	●	●	●					
2.2	●	●	●	●					
2.3	●	●	●						
2.4	●	●	●						
2.5	●	●	●						
2.6	●	●	●						
2.7	●	●							

The span table is used to show how the substructure needs to be dimensioned as a function of wind loads [kN/m²] according to national standards and the span widths of the profiles, which are determined (usually synonymous with floor height).

The substructure shown in the table comprises only the CW-stud 150/50/06. The fixing to the load-bearing structure is not considered. It is assumed that the profile is planked with a suitable board both sides (AQUAPANEL® Cement Board Outdoor on the exteriors and a gypsum based board on the interiors). An angle fixing of the profile to connect to the load-bearing structure is recommended in any case.

Please note: the table provides an indication for preliminary design purposes only. This must be subsequently verified by an object-related structural calculation, following the relevant local norms and guidelines. The choice of anchors and further fixing materials (e.g. angle fixing) to transfer the loads into the primary structure should only be made on the basis of this project-specific structural design.

Further profile solutions can be demonstrated by a simple proof of the fitness for use shown by a deformation limit of max. $f = l/300$.

- 600 mm stud spacing
- 400 mm stud spacing
- On request
- Back to back or boxed

Building-physical features

Heat transition coefficient* $U_w = U_0 + U_{WB, Profile}$ (undisturbed wall, metal profiles are taken into account) - [W/m ² K]	0.302
Thermal bridge heat transfer at slab edge (linear thermal transmittance) Psi-value/ Ψ -value - [W/mK]	0.449
Sound reduction index R_w^* - [dB]	59**
Fire performance (i ↔ o)	-

Temperature fields and isotherms*

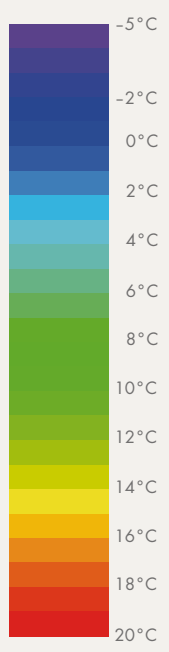
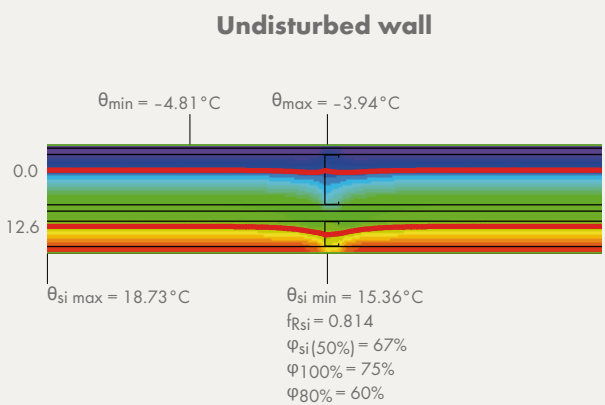
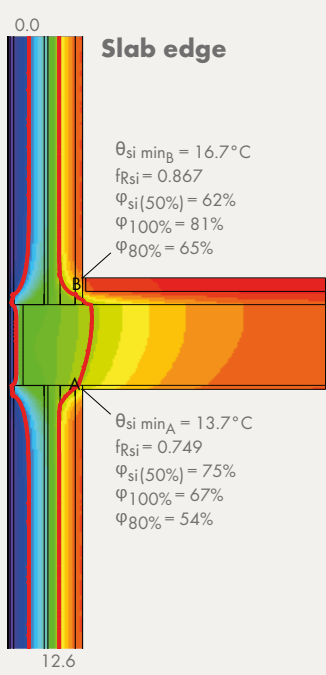

*Valid for a stud spacing of 600 mm and exterior profile web height of 100 mm **Calculated with INSUL (v9.0.1)



WM411C.2

Double stud, installed in front of floors.

By front-mounting the exterior stud frame of the WM411C.2 system on L-metal profiles, a significant amount of the insulation inside Knauf Exterior Wall is moved in front of the building floors. This solution significantly reduces thermal bridges to a minimum, whereby the heat is reliably kept inside the building in winter and outside during the summer. Here the thermal performance is further enhanced by installing an intermediate layer of insulation between the exterior and the interior stud frame. That way a thermal performance of $0.216 \text{ W}/(\text{m}^2\text{K})$ is accomplished, which is outstanding taking into account that the wall thickness is still only 245 mm.



Click or scan to get more information about this system



Knauf Interfer Stahl Service Center GmbH | Barsinghausen, Germany



Office building | Voerde, Germany



Office building | Voerde, Germany



Office building | Voerde, Germany

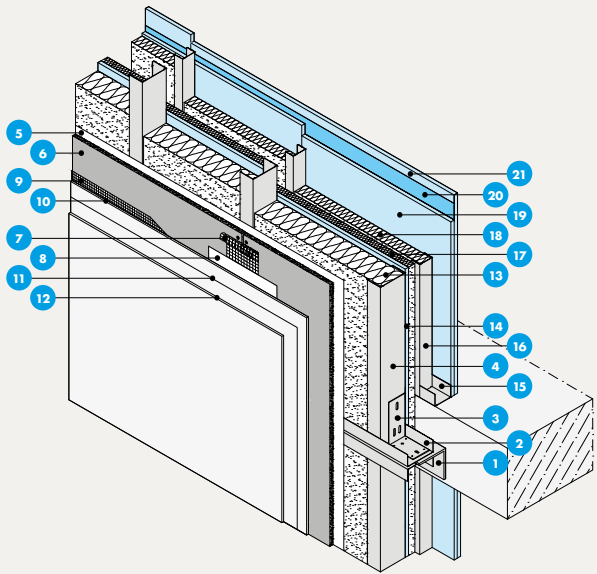

- 1 L-metal profile incl. anchoring device and decoupling from building
- 2 UW-stud (min. corrosion protection C3)
- 3 Steel angles (to be provided on site)
- 4 CW-stud (min. corrosion protection C3)
- 5 AQUAPANEL® Water Barrier
- 6 AQUAPANEL® Cement Board Outdoor
- 7 AQUAPANEL® Joint Tape (10 cm)
- 8 AQUAPANEL® Joint Filler - grey
- 9 AQUAPANEL® Reinforcing Mesh
- 10 AQUAPANEL® Exterior Basecoat - white
- 11 AQUAPANEL® Basecoat Primer
- 12 Render finish (e.g. AQUAPANEL® Exterior Mineral Finish - white)
- 13 Insulation board (thickness: 100 mm) according to local needs
- 14 Gypsum board: Knauf Wallboard impregnated 12.5 mm (GKBI/H2)¹ or similar
- 15 UW-stud 50/40/06 (min. corrosion protection C3)
- 16 CW-stud 50/50/06 (min. corrosion protection C3)
- 17 Insulation roll (thickness: 40 mm) according to local needs
- 18 Insulation board (thickness: 50 mm) according to local needs
- 19 Gypsum board: Knauf Wallboard impregnated 12.5 mm (GKBI/H2)¹ or similar
- 20 Vapour barrier: Knauf Insulation LDS 10 silk or similar
- 21 Gypsum board: Knauf Wallboard impregnated 12.5 mm (GKBI/H2)¹ or similar

¹ acc. to DIN 18180 and EN 520

➤ Wall thickness: 245 mm ➤ Weight: 67.26 kg/m² ➤ Construction time: 117 min/m²
 All figures are valid for a stud spacing of 600 mm, exterior profile web height of 100 mm and do not include the render finish

Economic advantages (example: office building)

Building perimeter:	88.1 m
Floor height:	3.5 m
Exterior wall surface per floor:	308.35 m ²
Number of floors:	3
Wall opening share:	33%
Opening surface:	305.26 m ²
Net exterior wall surface:	619.78 m ²

- Thickness: precast concrete parts + ETICS
- Thickness: WM411C.2
- Space gain

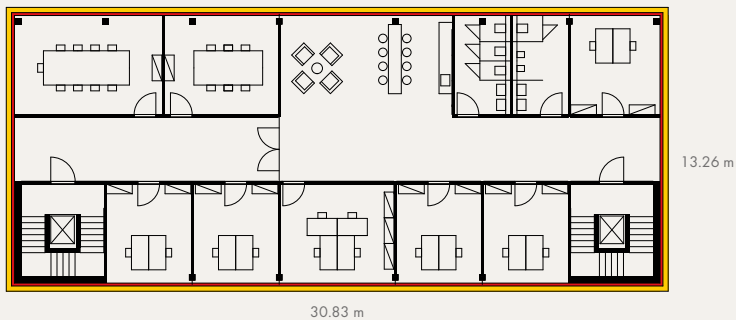

Cost-influencing factors*



55 tons	WM411C.2	316 tons	Precast concrete parts + ETICS	261 tons	Weight savings
---------	----------	----------	--------------------------------	----------	----------------



62 days	WM411C.2	63 days	Precast concrete parts + ETICS	1 days	Erection time savings
---------	----------	---------	--------------------------------	--------	-----------------------

Based on a specific intended use and location of a building, the dead weight is the most important factor of the total loads, which can be influenced by planning. Basically, lower loads enable a leaner structure and thus significant cost savings.

The calculation of explicit cost saving amounts for load-bearing walls and ceilings as well as foundations achieved by the weight reduction when using Knauf Exterior Wall is generically not possible, since this is always to be calculated project specifically on the basis of floor plan geometries, spans and the load-bearing capacity of the building ground.

With a longer production time, considerable costs for personnel employment are involved. Additionally, a longer building process means a longer supply of building site facilities, where costs should be minimised. The efficient construction of Knauf Exterior Wall as well as the shorter drying times and the significantly lower weather dependency compared to massive constructions offer a considerable cost reduction potential and entails much less risk in the planning of the construction process.

Revenue-influencing factors*

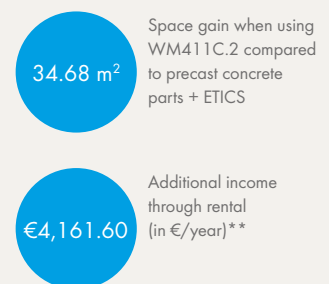

By using Knauf Exterior Wall more space can be realised inside the building with a comparable thermal insulation value. Consequently, rentable space and resulting rental income are larger. For landlords and investors, the best possible use of the land area plays an important role. By using Knauf Exterior Wall, this area efficiency and land utilisation are significantly improved.

*Figures are based on a study by Prof. Dr. Bert Bielefeld of the University of Siegen, Germany. All measurements use comparable U-values.

**Rental income based (in €/m² per month): €10.00

Preliminary design acc. to EN 1993-1-3 for CW 150/50/06

Wind load w_e (kN/m ²)	span (m); wall heights								
	2.4	2.6	2.8	3.0	3.2	3.4	3.6	3.8	4.0
0.4									
0.5									
0.6									●
0.7								●	●
0.8							●	●	●
0.9						●	●	●	●
1.0					●	●	●	●	●
1.1				●	●	●	●	●	●
1.2				●	●	●	●	●	●
1.3			●	●	●	●	●	●	
1.4			●	●	●	●	●	●	
1.5		●	●	●	●	●	●		
1.6		●	●	●	●	●			
1.7		●	●	●	●	●			
1.8	●	●	●	●	●				
1.9	●	●	●	●	●				
2.0	●	●	●	●	●				
2.1	●	●	●	●					
2.2	●	●	●	●					
2.3	●	●	●						
2.4	●	●	●						
2.5	●	●	●						
2.6	●	●	●						
2.7	●	●							

The span table is used to show how the substructure needs to be dimensioned as a function of wind loads [kN/m²] according to national standards and the span widths of the profiles, which are determined (usually synonymous with floor height).

The substructure shown in the table comprises only the CW-stud 150/50/06. The fixing to the load-bearing structure is not considered. It is assumed that the profile is planked with a suitable board both sides (AQUAPANEL® Cement Board Outdoor on the exteriors and a gypsum based board on the interiors). An angle fixing of the profile to connect to the load-bearing structure is recommended in any case.

Please note: the table provides an indication for preliminary design purposes only. This must be subsequently verified by an object-related structural calculation, following the relevant local norms and guidelines. The choice of anchors and further fixing materials (e.g. angle fixing) to transfer the loads into the primary structure should only be made on the basis of this project-specific structural design.

Further profile solutions can be demonstrated by a simple proof of the fitness for use shown by a deformation limit of max. $f = l/300$.

- 600 mm stud spacing
- 400 mm stud spacing
- On request
- Back to back or boxed

Building-physical features

Heat transition coefficient* $U_{wv} = U_0 + U_{WB, Profile}$ (undisturbed wall, metal profiles are taken into account) - [W/m ² K]	0.216
Thermal bridge heat transfer at slab edge (linear thermal transmittance) Psi-value/ Ψ -value - [W/mK]	0.324
Sound reduction index R_w * - [dB]	67**
Fire performance (i ↔ o)	EI30

Temperature fields and isotherms*

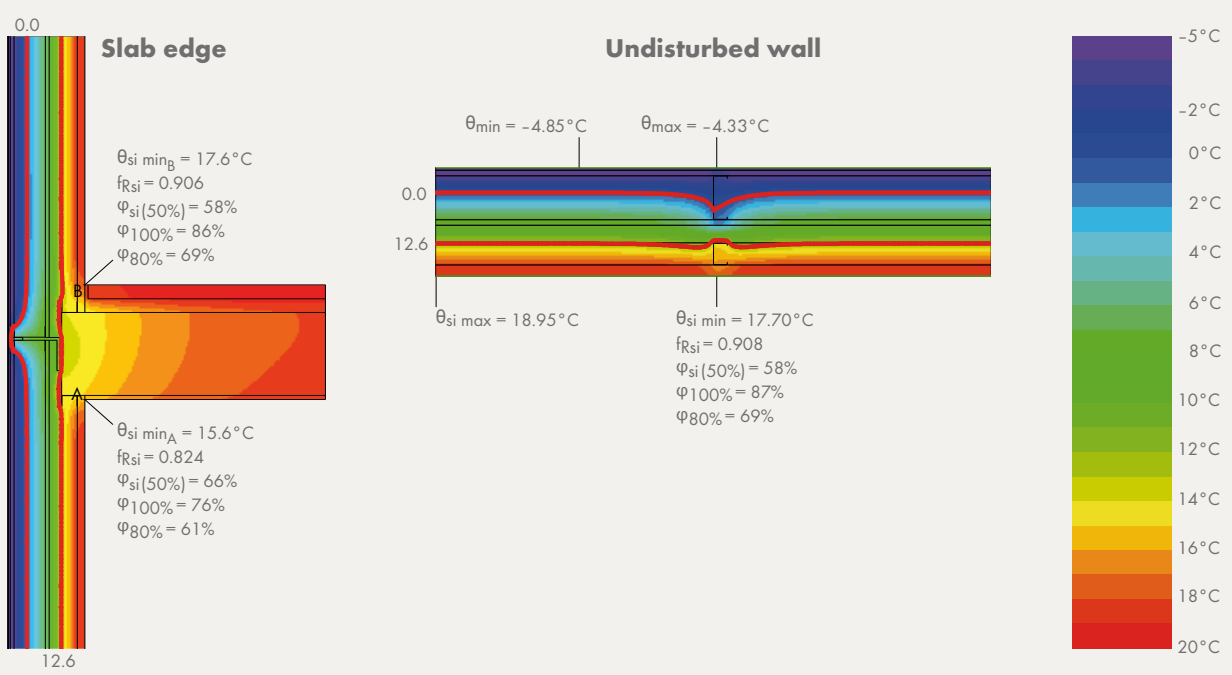

*Valid for a stud spacing of 600 mm and exterior profile web height of 100 mm **Calculated with INSUL (v9.0.1)



WM411C.3

Double stud, KEW profile, installed between floors.

Knauf AQUAPANEL® has developed the high-performance Knauf Exterior Wall facade profiles 150, which represent the substructure of the exterior stud frame. These profiles, combined with the associated Knauf Exterior Wall Steel Angle 70x135/100, the Knauf Exterior Wall Screw 4.8x20 and an appropriate concrete screw (e.g. Hilti HUS-HR 6), enable a preliminary static design according to EUROCODE 3, which accelerates the planning process for architects and structural engineers, because it takes all elements of Knauf Exterior Wall into account including the anchoring means, which transfer the loads into the primary construction. Additionally these profiles offer the necessary space for 150 mm thick insulation panels resulting - in this WM411C.3 system - in a thermal performance of 0.185 W/(m²K).

Click or scan to get more information about this system



Paulaner Brewery | Munich, Germany



Stadthaus V6 in Quartier 8 | Freiburg, Germany



Baggersand | Travemünde, Germany



Baggersand | Travemünde, Germany

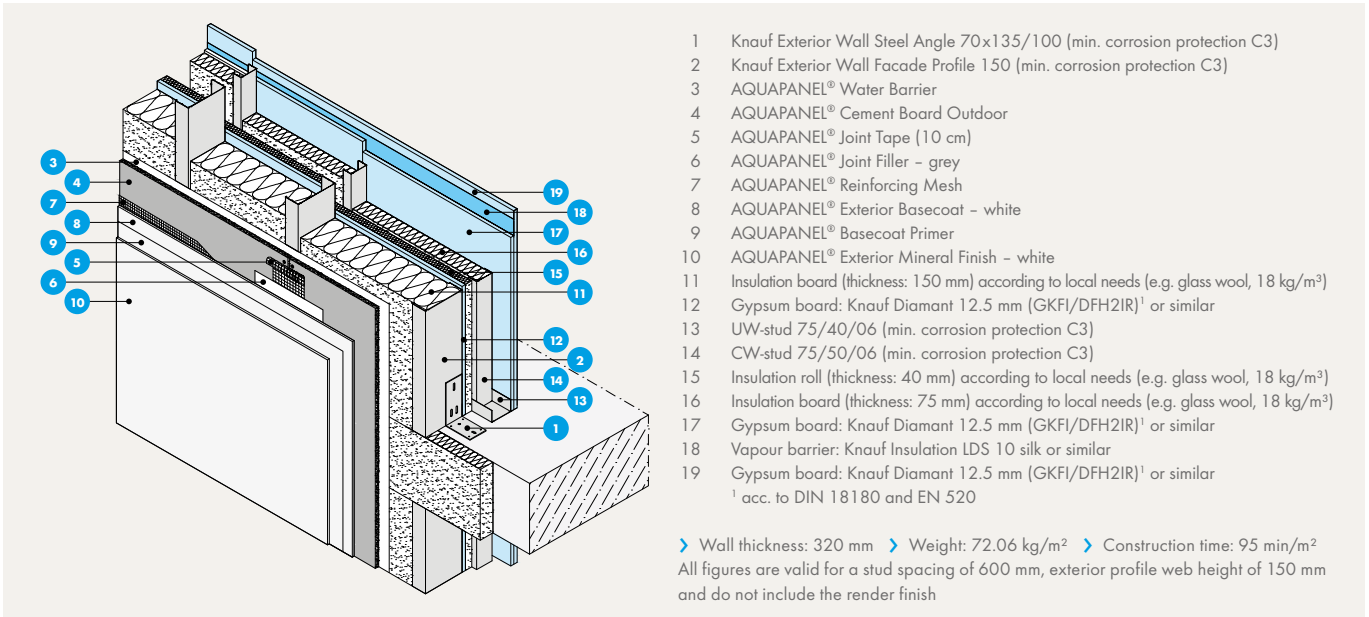

Economic advantages (example: high-rise residential building)

Building perimeter: 144 m
 Floor height: 3 m
 Exterior wall surface per floor: 432 m²
 Number of floors: 9
 Wall opening share: 25%
 Opening surface: 972 m²
 Net exterior wall surface: 2,916 m²

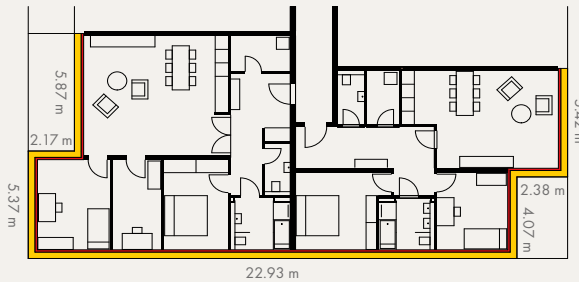

■ Thickness: precast concrete parts + ETICS
■ Thickness: WM411C.3
■ Space gain

Only one third of the building is shown
 Assumption: 3 living units per floor at 240.83m³ incl. hallway

Cost-influencing factors*



274 tons WM411C.3 1,489 tons Precast concrete parts + ETICS 1,215 tons Weight savings



236 days WM411C.3 260 days Precast concrete parts + ETICS 24 days Erection time savings

Based on a specific intended use and location of a building, the dead weight is the most important factor of the total loads, which can be influenced by planning. Basically, lower loads enable a leaner structure and thus significant cost savings.

The calculation of explicit cost saving amounts for load-bearing walls and ceilings as well as foundations achieved by the weight reduction when using Knauf Exterior Wall is generically not possible, since this is always to be calculated project specifically on the basis of floor plan geometries, spans and the load-bearing capacity of the building ground.

With a longer production time, considerable costs for personnel employment are involved. Additionally, a longer building process means a longer supply of building site facilities, where costs should be minimised. The efficient construction of Knauf Exterior Wall as well as the shorter drying times and the significantly lower weather dependency compared to massive constructions offer a considerable cost reduction potential and entails much less risk in the planning of the construction process.

Revenue-influencing factors*

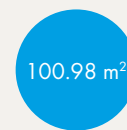

Space gain when using WM411C.3 compared to precast concrete parts + ETICS



Additional income through rental (in €/year)**

By using Knauf Exterior Wall more space can be realised inside the building with a comparable thermal insulation value. Consequently, rentable space and resulting rental income are larger. For landlords and investors, the best possible use of the land area plays an important role. By using Knauf Exterior Wall, this area efficiency and land utilisation are significantly improved.

*Figures are based on a study by Prof. Dr. Bert Bielefeld of the University of Siegen, Germany. All measurements use comparable U-values.

**Rental income based (in €/m² per month): €10.00

Preliminary design acc. to EN 1993-1-3 for Knauf Exterior Wall Profile 150

Wind load w_e (kN/m ²)	span (m); wall heights								
	2.4	2.6	2.8	3.0	3.2	3.4	3.6	3.8	4.0
0.4	600	600	600	600	600	600	600	600	600
0.5	600	600	600	600	600	600	600	600	600
0.6	600	600	600	600	600	600	600	600	600
0.7	600	600	600	600	600	600	600	600	600
0.8	600	600	600	600	600	600	600	600	600
0.9	600	600	600	600	600	600	600	600	600
1.0	600	600	600	600	600	600	600	600	400
1.1	600	600	600	600	600	600	600	400	400
1.2	600	600	600	600	600	600	400	400	400
1.3	600	600	600	600	600	400	400	400	On request
1.4	600	600	600	600	400	400	400	400	On request
1.5	600	600	600	400	400	400	400	400	On request
1.6	600	600	400	400	400	400	400	400	On request
1.7	600	600	400	400	400	400	400	400	On request
1.8	600	600	400	400	400	400	400	400	On request
1.9	600	600	400	400	400	400	400	400	On request
2.0	600	600	400	400	400	400	400	400	On request
2.1	600	600	400	400	400	400	400	400	On request
2.2	600	600	400	400	400	400	400	400	On request
2.3	600	400	400	400	400	400	400	400	On request
2.4	600	400	400	400	400	400	400	400	On request
2.5	600	400	400	400	400	400	400	400	On request
2.6	400	400	400	400	400	400	400	400	On request
2.7	400	400	400	400	400	400	400	400	On request

The span table is used to show how the substructure needs to be dimensioned as a function of wind loads [kN/m²] according to national standards and the span widths of the profiles, which are determined (usually synonymous with floor height).

The substructure shown in the table comprises a combination of the KEW profile 150, fixed to the KEW steel angle 70x135/100 with a KEW screw.

Please note: the table provides an indication for preliminary design purposes only. This must be subsequently verified by an object-related structural calculation, following the relevant local norms and guidelines. The choice of anchors to transfer the loads into the primary structure should only be made on the basis of this project-specific structural design.

- 600 mm stud spacing
- 400 mm stud spacing
- On request

Building-physical features

Heat transition coefficient* $U_w = U_0 + U_{WB, Profile}$ (undisturbed wall, metal profiles are taken into account) - [W/m ² K]	0.185
Thermal bridge heat transfer at slab edge (linear thermal transmittance) Psi-value/ Ψ -value - [W/mK]	0.172
Sound reduction index R_w^* - [dB]	73.8**
Fire performance (i ↔ o)	EI30

Temperature fields and isotherms*

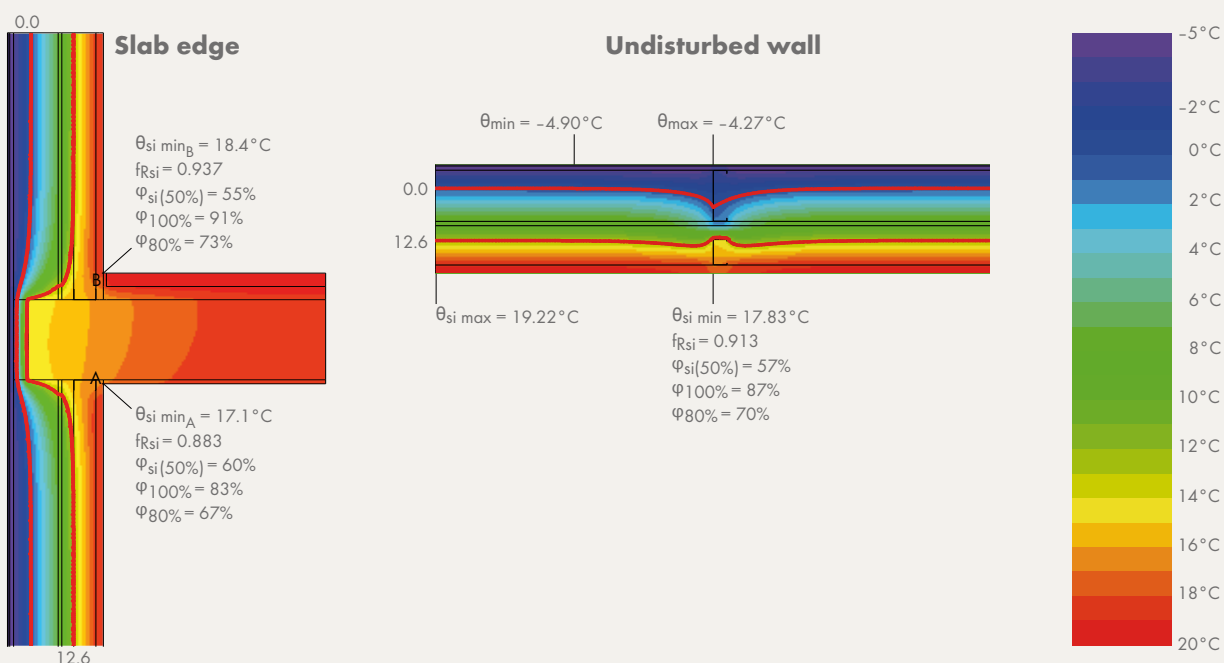

*Valid for a stud spacing of 600 mm **See test certificate PB SWW15 029



WM412C.1

Double stud, KEW profile, third-party rainscreen facade, installed between floors.

In this WM412C.1 system Knauf Exterior Wall facade profiles 150 are boxed in one another, providing the necessary support to allow for the attachment of cladding materials. The cladding is mounted to the AQUAPANEL® Cement Board Outdoor simply using a hat profile and because the required insulation is already installed inside the drywall, the advantages of drywall and rear-ventilated rainscreen facades are combined in a very thin construction of only 355 mm. With this solution the versatility of AQUAPANEL® Cement Board Outdoor becomes apparent: rather than simply being just a render carrier, it provides the basis for a wide range of decorative claddings, such as aluminium, granite stone and glass.

Click or scan to get more information about this system



Flow Tower | Cologne, Germany



Centro Gioventù e Sport | Bellinzona, Switzerland



Cloud No. 7 | Stuttgart, Germany



Cloud No. 7 | Stuttgart, Germany

- 1 Knauf Exterior Wall Steel Angle 70x135/100 (min. corrosion protection C3)
- 2 Knauf Exterior Wall Facade Profile 150 (min. corrosion protection C3) - boxed
- 3 AQUAPANEL® Water Barrier
- 4 AQUAPANEL® Cement Board Outdoor
- 5 AQUAPANEL® Joint Tape (10 cm)
- 6 AQUAPANEL® Joint Filler - grey
- 7 Hat profile (to be provided on site)
- 8 Rear-ventilated rainscreen facade system (to be offered by third-party supplier)
- 9 Insulation board (thickness: 150 mm) according to local needs
- 10 Gypsum board: Knauf Diamant 12.5 mm (GKFI/DFH2IR)¹ or similar
- 11 UW-stud 75/40/06 (min. corrosion protection C3)
- 12 CW-stud 75/50/06 (min. corrosion protection C3)
- 13 Insulation roll (thickness: 40 mm) according to local needs
- 14 Insulation board (thickness: 75 mm) according to local needs
- 15 Gypsum board: Knauf Diamant 12.5 mm (GKFI/DFH2IR)¹ or similar
- 16 Vapour barrier: Knauf Insulation LDS 10 silk or similar
- 17 Gypsum board: Knauf Diamant 12.5 mm (GKFI/DFH2IR)¹ or similar
¹ acc. to DIN 18180 and EN 520

> Wall thickness: 355 mm > Weight: 79.16 kg/m² > Construction time: 130 min/m²
 All figures are valid for a stud spacing of 600 mm, exterior profile web height of 150 mm and depend on the choice of the ventilated facade system (here: 40 mm wall thickness, 10 kg/m² weight and 45 min construction time)

Economic advantages (example: hospital extension)

Building perimeter:	61 m
Floor height:	4 m
Exterior wall surface per floor:	244 m ²
Number of floors:	2
Wall opening share:	25%
Opening surface:	122 m ²
Net exterior wall surface:	366 m ²

- Thickness: precast concrete parts + rear-ventilated rainscreen facade
- Thickness: WM412C.1
- Space gain

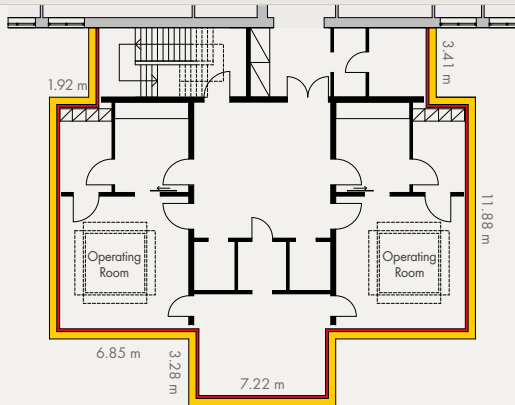

Cost-influencing factors*



29 tons WM412C.1

188 tons Precast concrete parts + rear-ventilated rainscreen facade

159 tons Weight savings

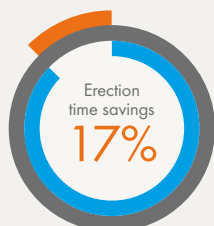

39 days WM412C.1

47 days Precast concrete parts + rear-ventilated rainscreen facade

8 days Erection time savings

Based on a specific intended use and location of a building, the dead weight is the most important factor of the total loads, which can be influenced by planning. Basically, lower loads enable a leaner structure and thus significant cost savings.

The calculation of explicit cost saving amounts for load-bearing walls and ceilings as well as foundations achieved by the weight reduction when using Knauf Exterior Wall is generically not possible, since this is always to be calculated project specifically on the basis of floor plan geometries, spans and the load-bearing capacity of the building ground.

With a longer production time, considerable costs for personnel employment are involved. Additionally, a longer building process means a longer supply of building site facilities, where costs should be minimised. The efficient construction of Knauf Exterior Wall as well as the shorter drying times and the significantly lower weather dependency compared to massive constructions offer a considerable cost reduction potential and entails much less risk in the planning of the construction process.

Revenue-influencing factors*

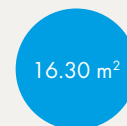

Space gain when using WM412C.1 compared to precast concrete parts + rear-ventilated rainscreen facade



Additional income through rental (in €/year)**

By using Knauf Exterior Wall more space can be realised inside the building with a comparable thermal insulation value. Consequently, rentable space and resulting rental income are larger. For landlords and investors, the best possible use of the land area plays an important role. By using Knauf Exterior Wall, this area efficiency and land utilisation are significantly improved.

* Figures are based on a study by Prof. Dr. Bert Bielefeld of the University of Siegen, Germany. All measurements use comparable U-values.

** Rental income based (in €/m² per month): €10.00

Preliminary design acc. to EN 1993-1-3 for Knauf Exterior Wall Profile 150 (boxed)

Wind load w_e (kN/m ²)	span (m); wall heights									
	2.4	2.6	2.8	3.0	3.2	3.4	3.6	3.8	4.0	
0.4	600	600	600	600	600	600	600	600	600	600
0.5	600	600	600	600	600	600	600	600	600	600
0.6	600	600	600	600	600	600	600	600	600	600
0.7	600	600	600	600	600	600	600	600	600	600
0.8	600	600	600	600	600	600	600	600	600	600
0.9	600	600	600	600	600	600	600	600	600	600
1.0	600	600	600	600	600	600	600	600	600	600
1.1	600	600	600	600	600	600	600	600	600	600
1.2	600	600	600	600	600	600	600	600	600	600
1.3	600	600	600	600	600	600	600	600	600	600
1.4	600	600	600	600	600	600	600	600	600	600
1.5	600	600	600	600	600	600	600	600	600	600
1.6	600	600	600	600	600	600	600	600	600	600
1.7	600	600	600	600	600	600	600	600	600	600
1.8	600	600	600	600	600	600	600	600	600	600
1.9	600	600	600	600	600	600	600	600	600	600
2.0	600	600	600	600	600	600	600	600	600	600
2.1	600	600	600	600	600	600	600	600	600	600
2.2	600	600	600	600	600	600	600	600	600	600
2.3	600	600	600	600	600	600	600	600	600	600
2.4	600	600	600	600	600	600	600	600	600	600
2.5	600	600	600	600	600	600	600	600	600	600
2.6	600	600	600	600	600	600	600	600	600	600
2.7	600	600	600	600	600	600	600	600	600	600

The span table is used to show how the substructure needs to be dimensioned as a function of wind loads [kN/m²] according to national standards and the span widths of the profiles, which are determined (usually synonymous with floor height).

The substructure shown in the table comprises a combination of the two boxed KEW profile 150, fixed to the KEW steel angle 70x135/100 with a KEW screw (boxed construction of the profile is needed to carry the loads of the third-party rainscreen facade).

Please note: the table provides an indication for preliminary design purposes only. This must be subsequently verified by an object-related structural calculation, following the relevant local norms and guidelines. The choice of anchors to transfer the loads into the primary structure should only be made on the basis of this project-specific structural design.

- 600 mm stud spacing
- 400 mm stud spacing
- On request

Building-physical features

Heat transition coefficient* $U_w = U_o + U_{WB, Profile}$ (undisturbed wall, metal profiles are taken into account) - [W/m ² K]	0.189
Thermal bridge heat transfer at slab edge (linear thermal transmittance) Psi-value/Psi-value - [W/mK]	0.172
Sound reduction index R_w * - [dB]	73.8**
Fire performance (i ↔ o)	EI30

Temperature fields and isotherms*

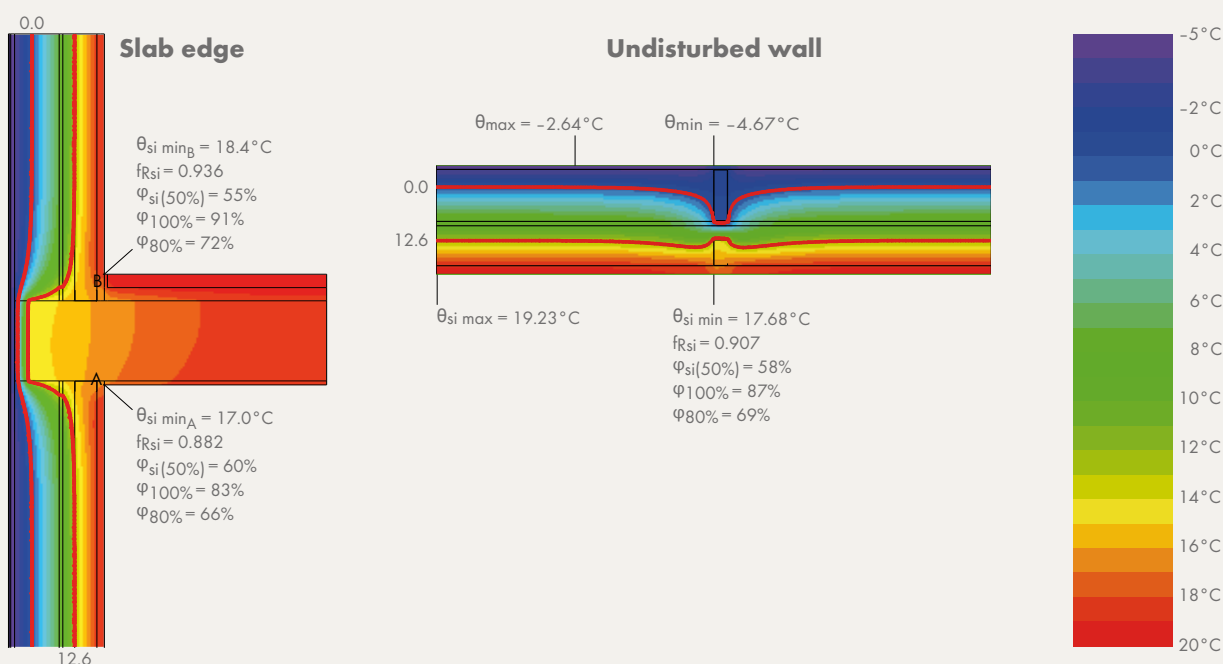

*Valid for a stud spacing of 600 mm **See test certificate PB SWW15 029 (Impact of rear-ventilated facade construction is not taken into account).



WM111C.1

Single stud.

With a profile of only 142.5 mm and an installation time of 82 min/m², the WM111C.1 system is a straightforward solution for buildings with no remarkably challenging requirements for sound and thermal insulation and for regions with low seasonal differences in temperature and humidity. It consists of a single metal stud frame planked with AQUAPANEL® Cement Board Outdoor on the outside and with a double layer of gypsum boards on the inside. For rooms with special priorities such as water resistance, acoustic control or fire resistance, those interior boards can easily be replaced by high-performance boards from Knauf's versatile range of wall linings.



Suzhou Olympic Sports Centre | Suzhou, China



MegaPlaza | Jaén, Peru



Car Park Utility Rooms | Stuttgart, Germany



German Pavillon EXPO 2010 | Shanghai, China

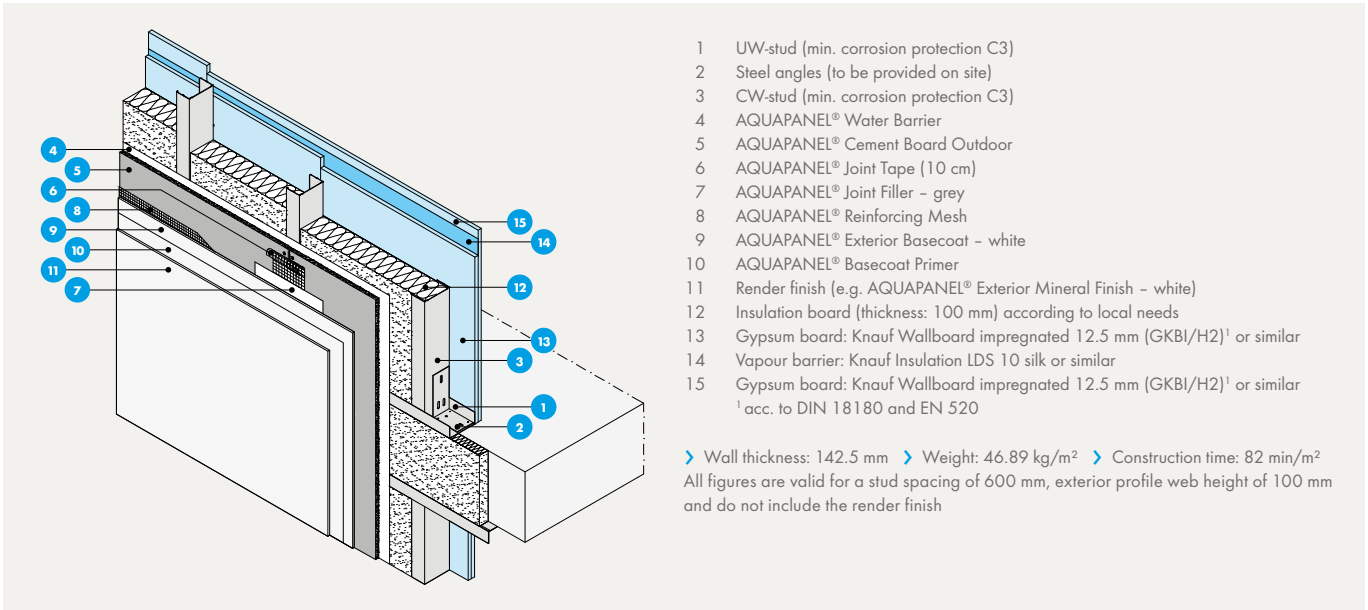

Economic advantages (example: retail shop)

Building perimeter:	135 m
Floor height:	5.5 m
Exterior wall surface per floor:	742.5 m ²
Number of floors:	1
Wall opening share:	50%
Opening surface:	371.25 m ²
Net exterior wall surface:	371.25 m ²

- Thickness: aerated concrete
- Thickness: WM111C.1
- Space gain

Only a part of the building is shown

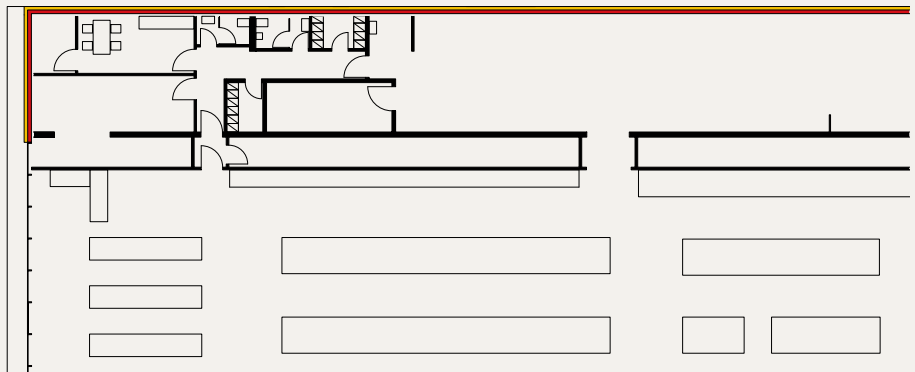

Cost-influencing factors*



26 tons WM111C.1 70 tons Aerated concrete 44 tons Weight savings

Based on a specific intended use and location of a building, the dead weight is the most important factor of the total loads, which can be influenced by planning. Basically, lower loads enable a leaner structure and thus significant cost savings.

The calculation of explicit cost saving amounts for load-bearing walls and ceilings as well as foundations achieved by the weight reduction when using Knauf Exterior Wall is generically not possible, since this is always to be calculated project specifically on the basis of floor plan geometries, spans and the load-bearing capacity of the building ground.

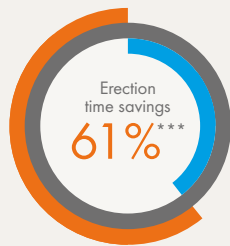

28 days WM111C.1 71 days Aerated concrete 43 days Erection time savings

With a longer production time, considerable costs for personnel employment are involved. Additionally, a longer building process means a longer supply of building site facilities, where costs should be minimised. The efficient construction of Knauf Exterior Wall as well as the shorter drying times and the significantly lower weather dependency compared to massive constructions offer a considerable cost reduction potential and entails much less risk in the planning of the construction process.

Revenue-influencing factors*

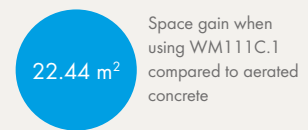

By using Knauf Exterior Wall more space can be realised inside the building with a comparable thermal insulation value. Consequently, rentable space and resulting rental income are larger. For landlords and investors, the best possible use of the land area plays an important role. By using Knauf Exterior Wall, this area efficiency and land utilisation are significantly improved.

*Figures are based on a study by Prof. Dr. Bert Bielefeld of the University of Siegen, Germany. All measurements use comparable U-values.

**Rental income based (in €/m² per month): €10.00

***The time saved due to the immediate window installation is taken into account (see page 11).

Preliminary design acc. to EN 1993-1-3 for CW 150/50/06

Wind load w_e (kN/m ²)	span (m); wall heights								
	2.4	2.6	2.8	3.0	3.2	3.4	3.6	3.8	4.0
0.4									
0.5									
0.6									●
0.7								●	●
0.8							●	●	●
0.9						●	●	●	●
1.0					●	●	●	●	●
1.1				●	●	●	●	●	●
1.2				●	●	●	●	●	●
1.3			●	●	●	●	●	●	●
1.4			●	●	●	●	●	●	●
1.5		●	●	●	●	●	●	●	●
1.6		●	●	●	●	●	●	●	●
1.7		●	●	●	●	●	●	●	●
1.8	●	●	●	●	●	●	●	●	●
1.9	●	●	●	●	●	●	●	●	●
2.0	●	●	●	●	●	●	●	●	●
2.1	●	●	●	●	●	●	●	●	●
2.2	●	●	●	●	●	●	●	●	●
2.3	●	●	●	●	●	●	●	●	●
2.4	●	●	●	●	●	●	●	●	●
2.5	●	●	●	●	●	●	●	●	●
2.6	●	●	●	●	●	●	●	●	●
2.7	●	●	●	●	●	●	●	●	●

The span table is used to show how the substructure needs to be dimensioned as a function of wind loads [kN/m²] according to national standards and the span widths of the profiles, which are determined (usually synonymous with floor height).

The substructure shown in the table comprises only the CW-stud 150/50/06. The fixing to the load-bearing structure is not considered. It is assumed that the profile is planked with a suitable board both sides (AQUAPANEL® Cement Board Outdoor on the exteriors and a gypsum based board on the interiors). An angle fixing of the profile to connect to the load-bearing structure is recommended in any case.

Please note: the table provides an indication for preliminary design purposes only. This must be subsequently verified by an object-related structural calculation, following the relevant local norms and guidelines. The choice of anchors and further fixing materials (e.g. angle fixing) to transfer the loads into the primary structure should only be made on the basis of this project-specific structural design.

Further profile solutions can be demonstrated by a simple proof of the fitness for use shown by a deformation limit of max. $f = l/300$.

- 600 mm stud spacing
- 400 mm stud spacing
- On request
- Back to back or boxed

Building-physical features

Heat transition coefficient* $U_{wv} = U_0 + U_{WB, Profile}$ (undisturbed wall, metal profiles are taken into account) - [W/m ² K]	0.486
Thermal bridge heat transfer at slab edge (linear thermal transmittance) Psi-value/ Ψ -value - [W/mK]	0.437
Sound reduction index R_w * - [dB]	54**
Fire performance (i ↔ o)	EI30

Temperature fields and isotherms*

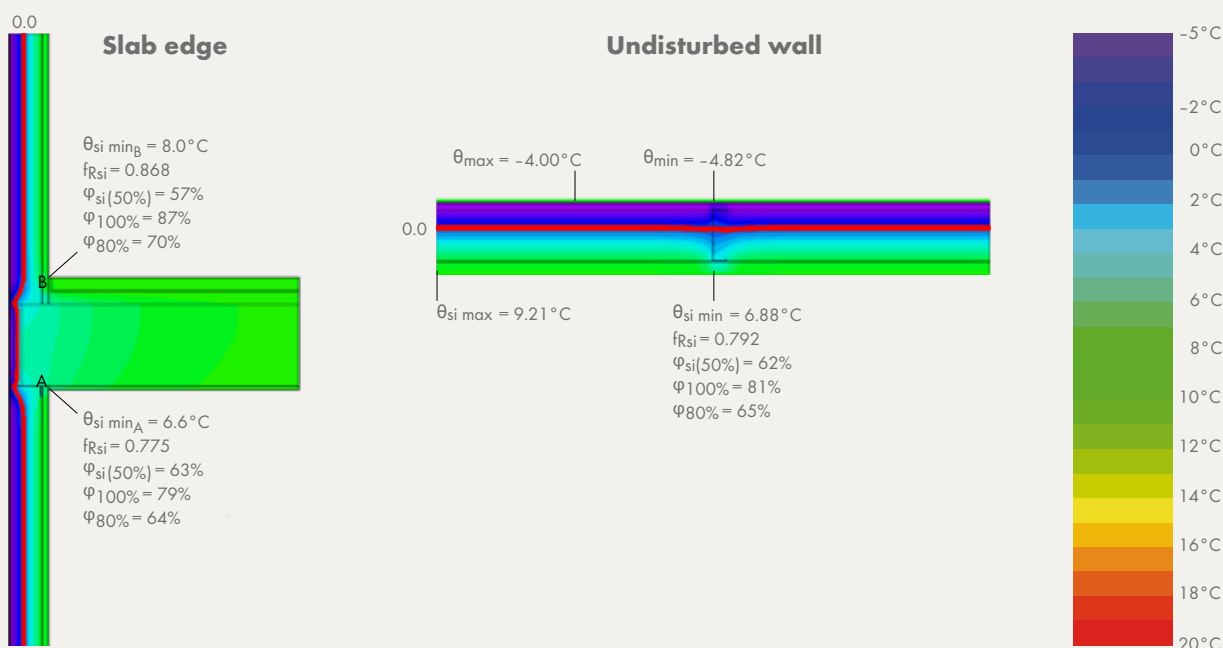

*Valid for a stud spacing of 600 mm and exterior profiles' web height of 100 mm **Calculated with INSUL (v9.0.1)



WM111C.2

Single stud, KEW profile, ETICS.

With the addition of an extra 80 mm thick layer of insulation to the system WM111C.2 by attaching an external thermal insulation composite system (ETICS) with an adhesive mortar directly on the AQUAPANEL® Cement Board Outdoor, an excellent thermal performance of 0.211 W/(m²K) can be achieved. Various desired U-values can be met by changing the thickness of the insulation. These mineral wool insulation panels are non-combustible, and as such comply with the highest levels of fire protection, guarantee an optimum room climate and additional sound insulation. Even additional fastenings with anchors may be waived depending on wind loads.

Click or scan to get more information about this system



Student Hostel | Esslingen, Germany



Student Hostel | Esslingen, Germany



Theater am Ring | Saarlouis, Germany



Theater am Ring | Saarlouis, Germany

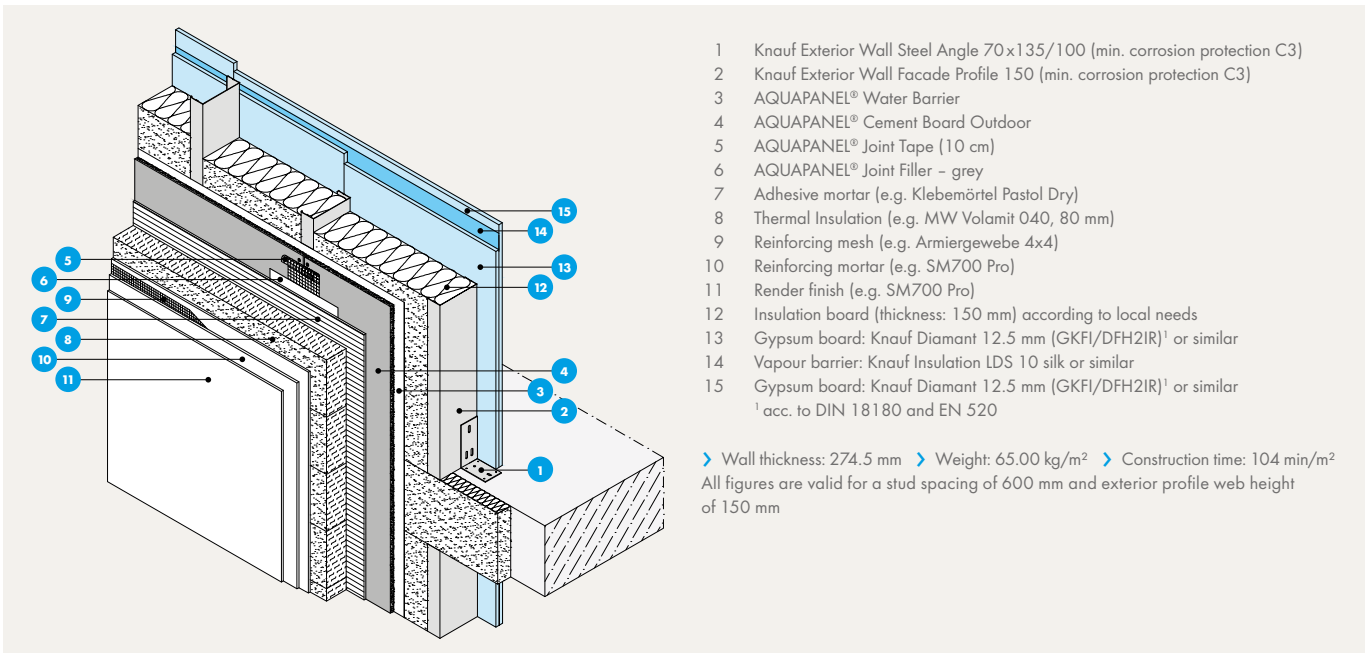

Economic advantages (example: office building)

Building perimeter:	88.1 m
Floor height:	3.5 m
Exterior wall surface per floor:	308.35 m ²
Number of floors:	3
Wall opening share:	33%
Opening surface:	305.26 m ²
Net exterior wall surface:	619.78 m ²

- Thickness: sand lime brick + ETICS
- Thickness: WM111C.2
- Space gain

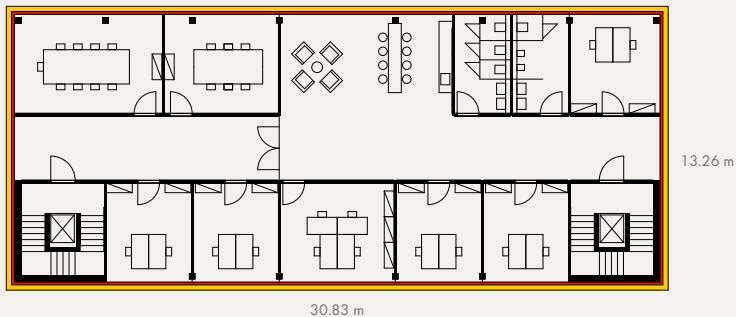

Cost-influencing factors*



54 tons WM111C.2 159 tons Sand lime brick + ETICS 105 tons Weight savings

Based on a specific intended use and location of a building, the dead weight is the most important factor of the total loads, which can be influenced by planning. Basically, lower loads enable a leaner structure and thus significant cost savings.

The calculation of explicit cost saving amounts for load-bearing walls and ceilings as well as foundations achieved by the weight reduction when using Knauf Exterior Wall is generically not possible, since this is always to be calculated project specifically on the basis of floor plan geometries, spans and the load-bearing capacity of the building ground.



57 days WM111C.2 65 days Sand lime brick + ETICS 8 days Erection time savings

With a longer production time, considerable costs for personnel employment are involved. Additionally, a longer building process means a longer supply of building site facilities, where costs should be minimised. The efficient construction of Knauf Exterior Wall as well as the shorter drying times and the significantly lower weather dependency compared to massive constructions offer a considerable cost reduction potential and entails much less risk in the planning of the construction process.

Revenue-influencing factors*



Space gain when using WM111C.2 compared to sand lime bricks + ETICS



Additional income through rental (in €/year)**

By using Knauf Exterior Wall more space can be realised inside the building with a comparable thermal insulation value. Consequently, rentable space and resulting rental income are larger. For landlords and investors, the best possible use of the land area plays an important role. By using Knauf Exterior Wall, this area efficiency and land utilisation are significantly improved.

*Figures are based on a study by Prof. Dr. Bert Bielefeld of the University of Siegen, Germany. All measurements use comparable U-values.

**Rental income based (in €/m² per month): €10.00

***If windows in the sand lime brick wall are not installed in the insulation layer, erection time savings increase to 50 days or 47% (see also page 11).

Preliminary design acc. to EN 1993-1-3 for Knauf Exterior Wall Profile 150

Wind load w_e (kN/m ²)	span (m); wall heights									
	2.4	2.6	2.8	3.0	3.2	3.4	3.6	3.8	4.0	
0.4	600	600	600	600	600	600	600	600	600	600
0.5	600	600	600	600	600	600	600	600	600	600
0.6	600	600	600	600	600	600	600	600	600	600
0.7	600	600	600	600	600	600	600	600	600	600
0.8	600	600	600	600	600	600	600	600	600	600
0.9	600	600	600	600	600	600	600	600	600	600
1.0	600	600	600	600	600	600	600	600	600	600
1.1	600	600	600	600	600	600	600	600	600	600
1.2	600	600	600	600	600	600	600	600	600	600
1.3	600	600	600	600	600	600	600	600	600	600
1.4	600	600	600	600	600	600	600	600	600	600
1.5	600	600	600	600	600	600	600	600	600	600
1.6	600	600	600	600	600	600	600	600	600	600
1.7	600	600	600	600	600	600	600	600	600	600
1.8	600	600	600	600	600	600	600	600	600	600
1.9	600	600	600	600	600	600	600	600	600	600
2.0	600	600	600	600	600	600	600	600	600	600
2.1	600	600	600	600	600	600	600	600	600	600
2.2	600	600	600	600	600	600	600	600	600	600
2.3	600	600	600	600	600	600	600	600	600	600
2.4	600	600	600	600	600	600	600	600	600	600
2.5	600	600	600	600	600	600	600	600	600	600
2.6	600	600	600	600	600	600	600	600	600	600
2.7	600	600	600	600	600	600	600	600	600	600

The span table is used to show how the substructure needs to be dimensioned as a function of wind loads [kN/m²] according to national standards and the span widths of the profiles, which are determined (usually synonymous with floor height).
The substructure shown in the table comprises a combination of the KEW profile 150, fixed to the KEW steel angle 70x135/100 with a KEW screw.

Please note: the table provides an indication for preliminary design purposes only. This must be subsequently verified by an object-related structural calculation, following the relevant local norms and guidelines. The choice of anchors to transfer the loads into the primary structure should only be made on the basis of this project-specific structural design.

- 600 mm stud spacing
- 400 mm stud spacing
- On request

Building-physical features

Heat transition coefficient* $U_w = U_0 + U_{WB, Profile}$ (undisturbed wall, metal profiles are taken into account) - [W/m ² K]	0.211
Thermal bridge heat transfer at slab edge (linear thermal transmittance) Psi-value/ Ψ -value - [W/mK]	0.028
Sound reduction index R_w * - [dB]	56 **
Fire performance (i ↔ o)	EI30

Temperature fields and isotherms *

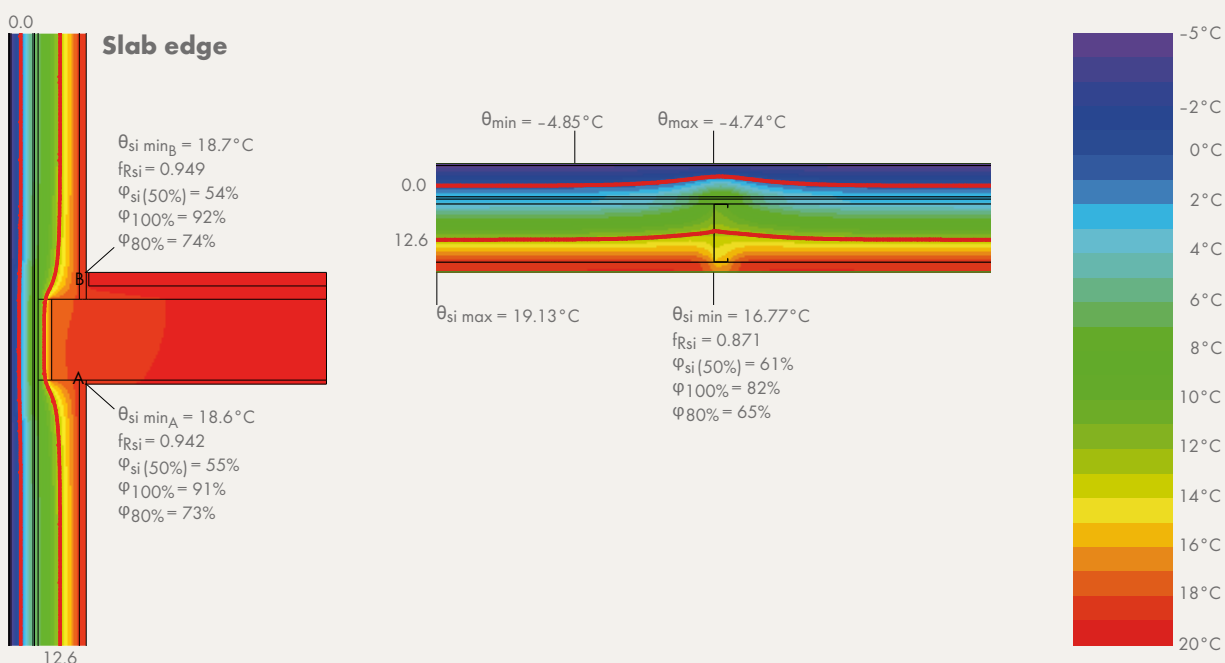

*Valid for a stud spacing of 600 mm **Calculated with INSUL (v9.0.1)



WL132C.1

Rear-ventilated rainscreen facade, with thermal insulation.

With classic rear-ventilated rainscreen facades in front of massive constructions such as brick or concrete, thermal insulation is separated from the weather protection materials ensuring a constant flow of air in the ventilated space to remove moisture from the building. The rear-ventilated rainscreen facade WL132C.1 with AQUAPANEL® Cement Board Outdoor is an ideal solution for new buildings or for renovations and upgrades. Capable of accommodating virtually any thickness of mineral wool insulation, it is able to meet even the most demanding energy standard. Moreover, because of the non-combustibility of the material, it is suitable for any height of building.

Click or scan to get more information about this system



Eagle in Flight | Tirana, Albania



Gerber Quartier | Stuttgart, Germany



Piller Blowers and Compressors | Moringen, Germany

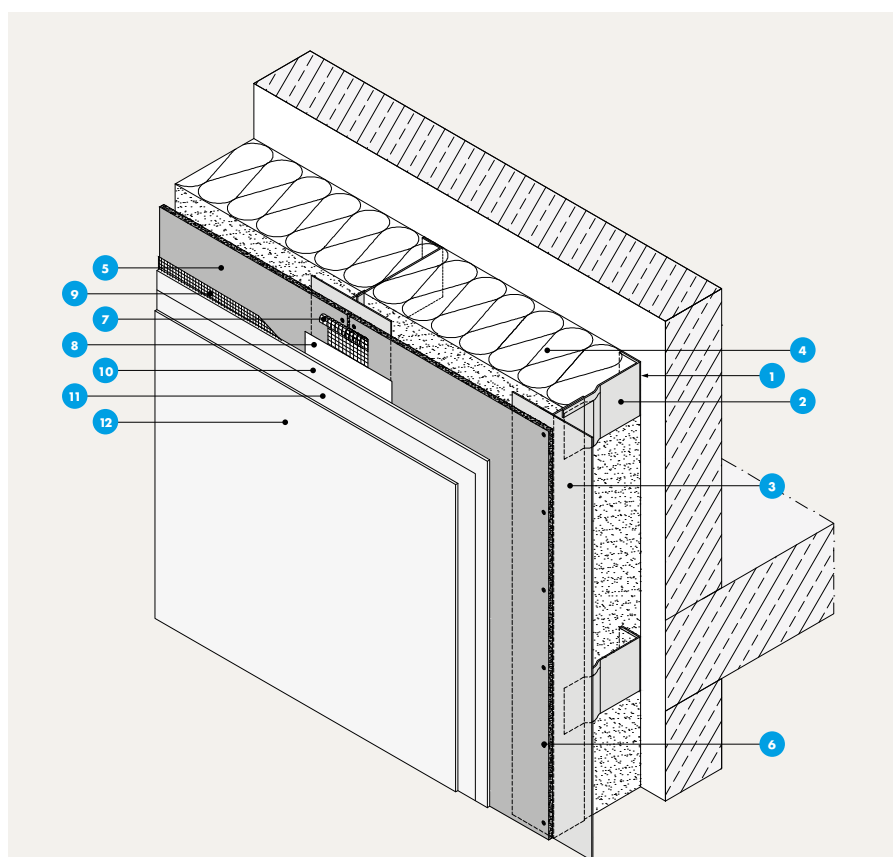

- | | |
|--|---|
| 1 Thermal separation element | ➤ Wall thickness: 230.5 mm |
| 2 Aluminium bracket | ➤ Weight: 30.10 kg/m ² |
| 3 T-profile 100x50x2 mm | ➤ Construction time: 85 min/m ² |
| 4 Insulation board according to local needs | ➤ Fire performance: A2 |
| 5 AQUAPANEL® Cement Board Outdoor | All figures are valid for a profile spacing of 600 mm and do not include the substrate wall and the render finish |
| 6 AQUAPANEL® Rustproofed Screw SB40 | |
| 7 AQUAPANEL® Joint Tape (10 cm) | |
| 8 AQUAPANEL® Joint Filler - grey | |
| 9 AQUAPANEL® Reinforcing Mesh | |
| 10 AQUAPANEL® Exterior Basecoat - white | |
| 11 AQUAPANEL® Basecoat Primer | |
| 12 Render finish (e.g. AQUAPANEL® Exterior Mineral Finish - white) | |



WL132C.2

Rear-ventilated rainscreen facade, without thermal insulation.

On projects where insulation is not required – typically during some purely cosmetic renovations – Knauf Exterior Wall can be used to create very thin rear-ventilated rainscreen facade constructions. In this WL132C.2 system the facade thickness in front of the existing massive wall is just 65 mm, making it the ideal solution in urban environments where limited space is a crucial factor in the decision for a particular construction. Additionally, the fast and easy installation and low weight of the materials guarantee a low impact construction site, keeping noise pollution and traffic interference to a minimum.

Click or scan to get more information about this system



Hard Rock Hotel | Ibiza, Spain



Hard Rock Hotel | Ibiza, Spain



High Performance Rowing Centre | Pocinho, Spain

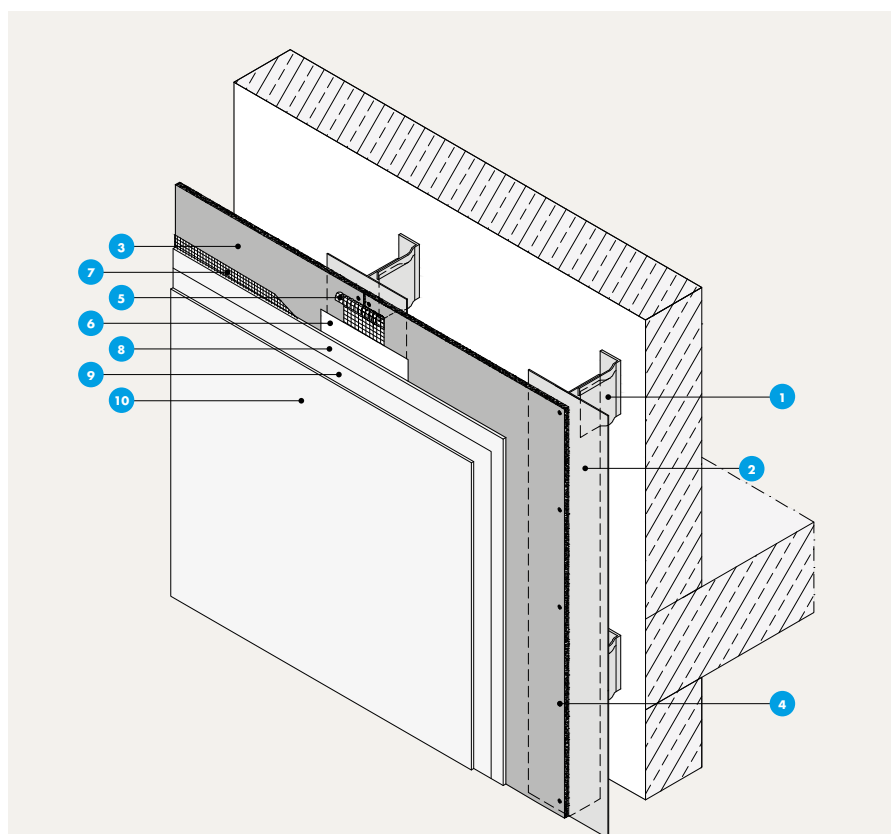

- | | | | |
|----|---|---|---|
| 1 | Aluminium bracket (e.g. depth: 60 mm) | ➤ | Wall thickness: 97.5 mm |
| 2 | T-profile 100x50x2 mm | ➤ | Weight: 25.80 kg/m ² |
| 3 | AQUAPANEL® Cement Board Outdoor | ➤ | Construction time: 65 min/m ² |
| 4 | AQUAPANEL® Rustproofed Screw SB40 | ➤ | Fire performance: A2 |
| 5 | AQUAPANEL® Joint Tape (10 cm) | | All figures are valid for a profile spacing of 600 mm and do not include the substrate wall and the render finish |
| 6 | AQUAPANEL® Joint Filler – grey | | |
| 7 | AQUAPANEL® Reinforcing Mesh | | |
| 8 | AQUAPANEL® Exterior Basecoat – white | | |
| 9 | AQUAPANEL® Basecoat Primer | | |
| 10 | Render finish (e.g. AQUAPANEL® Exterior Mineral Finish – white) | | |

WT121C.1

Timber frame construction, single stud.



Housing Development | Ringwood, United Kingdom



Housing Development | Ringwood, United Kingdom

The benefits of timber construction

Timber construction has long been considered as suitable almost exclusively for small scale buildings – and mainly in rural areas. However, new system developments have expanded design opportunities across the whole construction sector. These include for building redevelopments

using floor extensions in lightweight timber frame construction, as well as multilevel new buildings with a load-bearing skeleton construction.

The benefits of timber construction include prefabrication and fast onsite assembly, together with the fact that

timber is a natural, sustainable and renewable building material which serves as long-term CO₂ storage (1 m³ = 1 ton CO₂). Nor does it consume much grey energy in production and transport.

Knauf Exterior Wall is an ideal and

WT222C.1

Timber frame construction, single stud, interior installation level, ventilated.



Essex Business School | Colchester, United Kingdom



Essex Business School | Colchester, United Kingdom

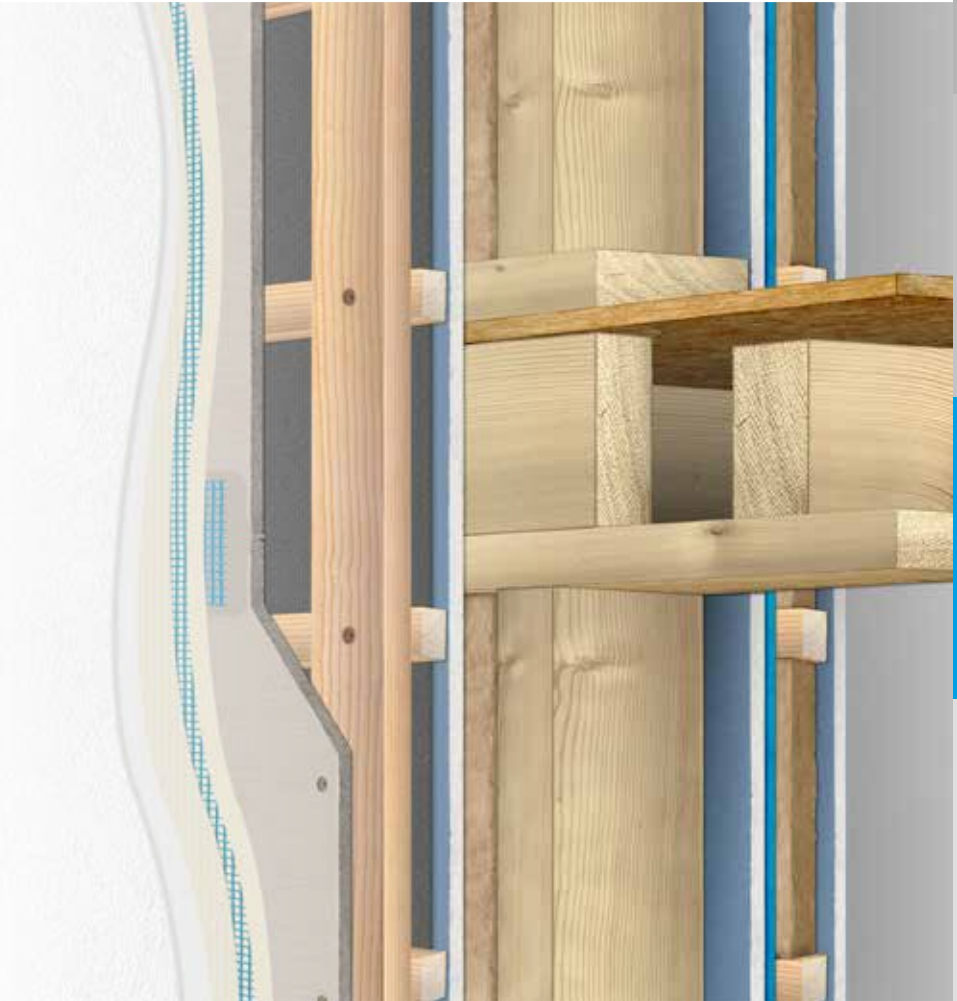

versatile partner for use in timber frames and on timber battens. The basic timber construction systems of Knauf Exterior Wall include a ventilated version and a non-ventilated option. In addition, an installation level for cables and pipes can be added on the inside. Also in timber construction, AQUAPANEL®

Cement Board Outdoor remains the central component in the exterior wall construction.

Providing a solid, dry base that can withstand extreme weathering, AQUAPANEL® Cement Board Outdoor can be fixed on the timber frame either

directly or with a ventilation gap using AQUAPANEL® Rustproofed Screws or staples (e.g. Haubold). The system is then ready to receive a render or paint finish or further exterior cladding such as brick slips or tiles.

WM422C.1

Cocoon, prefabricated facade modules.

The ETA approved Cocoon solution is a lightweight steel construction and has established itself as an easy building solution across a wide range of projects, especially those with complex 3D geometries. Combined with Knauf Exterior Wall with AQUAPANEL® Technology, many new and imaginative solutions for the building shell have become possible, including floor additions, new builds and structural extensions. At the heart of Cocoon lies a

system of prefabricated cold-rolled light steel frames, called Transformer, which can be delivered just in time for final assembly at the construction site, minimising storage and building waste while accelerating construction of the building shell. Attaching Knauf Exterior Wall to this shell has many benefits, including the elimination of drying time and shorter, uninterrupted construction schedules, regardless of weather conditions. The net result is a

significant cost advantage compared with traditional systems. Cocoon and Knauf Exterior Wall are particularly suited to modular constructions – such as in the health and education sectors – where provisional buildings are urgently needed for care and teaching.

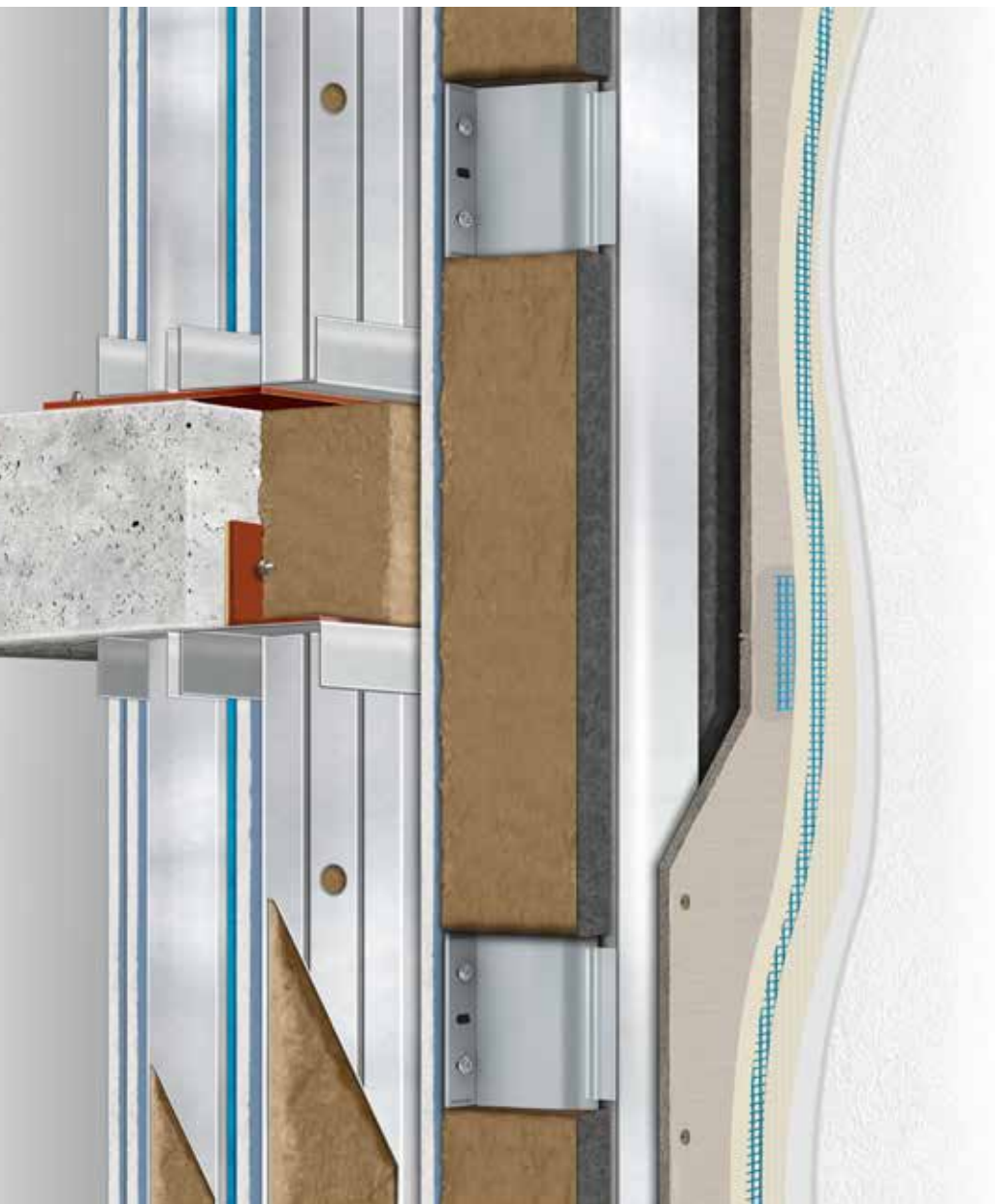

Südpark | Basel, Switzerland



Knauf AMF Office Building | Grafenau, Germany

WM122C.1

Cocoon, lightweight load-bearing steel-frame construction

The impressive load-bearing properties of Cocoon's steel system mean that extremely lightweight designs can be achieved. This capability is further enhanced by using Knauf Exterior Wall with AQUAPANEL® Cement Board Outdoor, helping to make further savings in terms of materials, energy and costs compared with traditional methods such as reinforced concrete. Additionally, the slim steel frames and slim profile of

AQUAPANEL® Cement Board Outdoor contribute significantly to space savings.

While these advantages apply to new builds, they're equally valid for extensions and reutilisations of buildings which – in Europe – account for almost 60% of construction. In addition to being economically and ecologically justified, the re-imagining of an existing structure is a cost-effective way of increasing space and

the value of the property. Floor extension is a typical example of how Cocoon – in conjunction with Knauf Exterior Wall – provides an easy and cost effective solution. The low weight allows for floor extensions without any reinforcement measures of the existing structures. The system is especially suited to high rise buildings, where the non-combustibility of materials is mandatory.



Single-family house | Kleinandelfingen, Switzerland



Orange House | Ankara, Turkey













PRODUCT RANGE

Stud framework



Easy to work with and install, the components used to create our stud frames include profiles, angles, screws and sealing strips, all available in a wide range of specifications and geometries to meet any design requirement. All profiles have organic coating and galvanizing (min. corrosion category C3 according to EN ISO 12944) to ensure long-term protection.





Profiles			Web height (mm)	Flange width (mm)	Nominal thickness (mm)	Weight (approx kg/m)
Knauf Exterior Wall Profile 150		<ul style="list-style-type: none"> › Point of use: exterior stud frame › Designed to absorb and transmit wind and dead loads › Interlaceable › Enables a preliminary static design according to EUROCODE 3 (in combination with Knauf Exterior Wall Steel Angle and Knauf Exterior Wall Screw) › Black coated › Minimum corrosion protection C3 	150	50	1.0	2.0
		<p>Click or scan for datasheet </p>				
CW Profiles		<ul style="list-style-type: none"> › Point of use: exterior and interior stud frame › Black coated › Minimum corrosion protection C3 	50	50	0.6	0.7
			75			0.8
			100			0.9
			125			1.0
			150			1.2
UW Profiles		<ul style="list-style-type: none"> › Point of use: exterior and interior stud frame › Black coated › Minimum corrosion protection C3 	50	40	0.6	0.5
			75			0.7
			100			0.8
			125			0.9
			150			1.0

Profiles			Web height (mm)	Flange width (mm)	Nominal thickness (mm)	Weight (approx kg/m)	
UA Profiles		<ul style="list-style-type: none"> ▶ Point of use: exterior and interior stud frame ▶ Black coated ▶ Minimum corrosion protection C3 ▶ With single-row perforation (web height 50 mm) or two-row perforation (web height 75-100 mm) 	50	40	2.0	1.7	
			75			2.0	
			100			2.3	
Connecting angles				Width (mm)	Length (mm)	Nominal thickness (mm)	
Knauf Exterior Wall Steel Angle 70x135/100		<ul style="list-style-type: none"> ▶ Black coated ▶ Enables a preliminary static design according to EUROCODE 3 (in combination with Knauf Exterior Wall Profile and Knauf Exterior Wall Screw) ▶ Minimum corrosion protection C3 	70	135/100	1.5		
Anschlusswinkel (Korrosionsschutz C3 – C5M)		<ul style="list-style-type: none"> ▶ Black coated ▶ Package incl. 8 rotary pin dowels 6/60 mm, 8 carriage bolts M 8/25 mm, 8 nuts M8, 8 washers ▶ For UA profiles 	50	80	1.5		
			75				
			100				
Screws and anchors					Width (mm)	Length (mm)	
Knauf Exterior Wall Screw		<ul style="list-style-type: none"> ▶ Rustproofed screw ▶ Hardened nail tip ▶ Suitable for metal thickness up to 1.2 mm ▶ Enables a preliminary static design according to EUROCODE 3 (in combination with Knauf Exterior Wall Profile and Knauf Exterior Wall Steel Angle) 	4.8	20			
Deckennagel Korrosionsschutz A4		<ul style="list-style-type: none"> ▶ Rustproofed steel A4 ▶ To attach steel profiles to reinforced concrete ▶ Borehole diameter: 6 mm ▶ Borehole depth: 45 mm ▶ Also for fire-protection constructions 	6.0	30			
Universal-Schraube FN		<ul style="list-style-type: none"> ▶ To connect clips or suspension devices to timber and metal ▶ Incl. one bit/package 	4.3	35			
				65			
Decoupling tape				Width (mm)	Roll length (mm)	Thickness (mm)	Nominal thickness (mm)
Decoupling Tape		<ul style="list-style-type: none"> ▶ Self-adhesive on one side ▶ To separate profiles from connections to walls, ceilings, columns and floor connections ▶ To reduce thermal and sound bridges ▶ In double stud systems used only in interior stud frame 	30	30,000	3.2	1.5	
			50				
			70				
			95				

Insulation







Available in panels and rolls for easy installation, mineral wool from Knauf Insulation is suitable for a wide range of applications, including inside stud frames, in the space between interior and exterior frames, as well as in front of floors to reduce thermal bridges between Knauf Exterior Wall with AQUAPANEL Technology® and concrete slabs. It is also used as an insulation board in rear-ventilated rainscreen facade systems. In addition, Knauf's MW Volamit 040 is widely used for ETICS applications and is available in easy to handle lamella formats and does not require the use of dowelling.













Insulation for metal constructions			Width (mm)	Length (mm)	Thickness (mm)	m ² /package
Knauf Insulation Metallbau-Dämmplatte FCB 035 	<ul style="list-style-type: none"> ▶ Insulation board ▶ Thermal conductivity rating: 035 ▶ Glass mineral wool ▶ ECOSE® Technology ▶ Non-combustible 	625	1,250	50	9.38	
				75	6.25	
				150	3.13	
Knauf Insulation Universalrolle Classic 035 	<ul style="list-style-type: none"> ▶ Insulation roll ▶ Thermal conductivity rating: 035 ▶ Glass mineral wool ▶ ECOSE® Technology ▶ Non-combustible 	1,200	13,000	40	15.60	
			10,500	50	12.60	
			8,700	60	10.44	
			6,300	80	7.56	
			5,200	100	6.24	
			4,400	120	5.28	
			3,700	140	4.44	
			3,300	160	3.96	
			2,900	180	3.48	
			2,600	200	3.12	
			2,900	220	3.48	
			2,700	240	3.24	
Mineral wool lamella for External Thermal Insulation Composite Systems (ETICS)			Width (mm)	Length (mm)	Thickness (mm)	m ² /pcs
MW Volamit 040 	<ul style="list-style-type: none"> ▶ Stone mineral wool lamella ▶ Non-combustible ▶ Double-sided adhesive coating (only for thicknesses 60 mm-220 mm) ▶ Thermal conductivity rating: 040 ▶ Pressure-resistant 	200	1,200	60	0.24	
				80		
				100		
				120		
				140		
				160		
				180		
				200		
				220		
				240		
				260		
				280		
				300		
Special thicknesses ≤ 300						

Adhesive mortar for mineral wool insulation (ETICS)			Coverage (approx kg/m ²)	Storage life (approx month)	Weight (kg/bag)	
Pastol Dry		<ul style="list-style-type: none"> Organic powder-based adhesive mortar in External Thermal Insulation Composite Systems (ETICS) For bonding mineral wool to board materials Fibre-reinforced Water-repellent Colour: natural white 	2.4 (2 mm layer thickness)	12	20	
Insulation board for ventilated facades			Width (mm)	Length (mm)	Thickness (mm)	m ² /package
Knauf Insulation Fassaden-Dämmplatte TP 435 B		<ul style="list-style-type: none"> Facade insulation board Thermal conductivity rating: 035 Glass mineral wool ECOSE® Technology With glass fleece backing on one side Non-combustible 	600	1,250	40	9.00
					60	6.00
					80	4.50
					100	3.75
					120	3.00
					140	2.25
					160	
					180	
Knauf Insulation Fassaden-Dämmplatte FPL-035		<ul style="list-style-type: none"> Facade insulation board Thermal conductivity rating: 035 Stone mineral wool Suitable for areas of fire flashover Non-combustible 	625	1,200	30	12.00
					50	7.50
					60	6.00
					80	4.50
					100	3.75
					120	3.00
					140	2.25
					160	
180						
Knauf Insulation Dämmstoffhalter		<ul style="list-style-type: none"> For fixing of facade insulation boards made of glass or stone mineral wool in concrete or brickwork in rear-ventilated rainscreen facade constructions 	90	90	60	
					80	
					100	
					120	
					140	
					160	
					180	
					200	

Exterior lining

To ensure that Knauf Exterior Wall acquires its water resistant properties, AQUAPANEL® Cement Board Outdoor is fitted on top of AQUAPANEL® Water Barrier, a highly windproof, rainproof and permeable layer which can be easily fixed on exterior studs by using adhesive tape. Complemented with specially developed system accessories including AQUAPANEL® Joint Filler, AQUAPANEL® Tape as well as AQUAPANEL® Maxi Screws with special coatings for added corrosion protection, the result is a complete – and completely reliable – lining system of AQUAPANEL® products.

Water barrier				Width (mm)	Roll length (mm)		
AQUAPANEL® Water Barrier		<ul style="list-style-type: none"> Water resistant and wind tight membrane Used as a water conducting layer directly behind AQUAPANEL® Cement Board Outdoor Diffusion equivalent air layer thickness (sd): 0.025 m 	 <p>Click or scan for datasheet</p>	1,500	50,000		
Adhesives tapes				Width (mm)	Roll length (mm)		
Knauf Insulation LDS Solitop		<ul style="list-style-type: none"> One-sided reinforced adhesive tape made of polyethylene Specially developed for outdoor use Used for bonding overlaps and penetrations of AQUAPANEL® Water Barrier 	 <p>Click or scan for datasheet</p>	60	40,000		
				150	25,000		
Cement boards			Width (mm)	Length (mm)	Thickness (mm)	Weight (approx kg/m ²)	
AQUAPANEL® Cement Board Outdoor		<ul style="list-style-type: none"> Cement board Easy Edge™ Building material class: A1, non-combustible 100% water resistant Bending radius 1-3 m (in dry state) 	 <p>Click or scan for datasheet</p>	900	1,200	12.5	16
				900	1,250		
				900	2,400		
				900	2,500		
				1,200	900		
				1,200	2,000		
				1,200	2,400		
				1,200	2,500		
				1,200	2,800		
				1,200	3,000		
				1,250	900		
				1,250	2,000		
1,250	2,500						

Screws			Length (mm)
AQUAPANEL® Maxi Screw SN25	 	▶ With countersunk head and nail tip	25
AQUAPANEL® Maxi Screw SN39			39
AQUAPANEL® Maxi Screw SN55			55
			Click or scan for datasheet 
AQUAPANEL® Maxi Screw SB25	 	▶ With countersunk head and drill tip	25
AQUAPANEL® Maxi Screw SB39			39
			Click or scan for datasheet 
AQUAPANEL® Rustproofed Screw SN40	 	▶ With countersunk head and nail tip ▶ Stainless steel	40
			Click or scan for datasheet 
AQUAPANEL® Rustproofed Screw SB40	 	▶ To fix AQUAPANEL® Cement Board Outdoor on aluminium substructure ▶ With countersunk head and drill tip ▶ Stainless steel	40
			Click or scan for datasheet 

Material of substructure	Steel framework				Aluminium framework	Timber framework	
	0.6mm ≤ x ≤ 1.0mm		1.0mm < x ≤ 2.0mm			≤ 2.0 mm	-
Metal thickness							
Amount of board layers	Single layer	Double layer	Triple layer	Single layer	Double layer	Single layer	Double layer
AQUAPANEL® Maxi Screw SN25	x						
AQUAPANEL® Maxi Screw SN39	x	x				x	
AQUAPANEL® Maxi Screw SN55			x				x
AQUAPANEL® Maxi Screw SB25				x			
AQUAPANEL® Maxi Screw SB39				x	x		
AQUAPANEL® Rustproofed Screw SN40						x*	
AQUAPANEL® Rustproofed Screw SB40					x		







*only necessary in ventilated constructions









Joint filler			Coverage (ca. kg/m ²)	Storage life (approx month)	Weight (kg/bag)
AQUAPANEL® Joint Filler – grey 	<ul style="list-style-type: none"> › Cement-bound joint filling material › Full-surface skimcoating of joints › Reinforced with AQUAPANEL® Tape 10 cm 	0.7	12	20	
			 Click or scan for datasheet		
Joint tapes				Width (mm)	Roll length (mm)
AQUAPANEL® Tape 10 cm 	<ul style="list-style-type: none"> › Glass fabric joint tape › Alkali-resistant coating › Colour: blue › Mesh size: 4x4 mm 		 Click or scan for datasheet	100	50,000
				100	20,000
AQUAPANEL® Exterior Reinforcing Tape 	<ul style="list-style-type: none"> › Glass fabric joint tape › Alkali-resistant coating › Colour: blue › Mesh size: 4x4 mm 		 Click or scan for datasheet	200	50,000



Exterior finishing

Knauf Exterior Wall is able to accommodate a wide range of finishes, so whatever you want to create, it's achievable. In terms of render, AQUAPANEL® has a range of products in its portfolio, including AQUAPANEL® Exterior Basecoat, AQUAPANEL® Reinforcing Mesh, AQUAPANEL® Basecoat Primer and a range of finishing renders. In addition, Knauf offers a selection of renders to increase choice and design possibilities. Knauf Exterior Wall is also compatible with a wide range of third-party finishes, including cladding, brick slips, tiles and paint, so there is no limit on design potential.

Basecoats			Coverage (ca. kg/m ²)	Storage life (approx month)	Weight (kg/bag)
AQUAPANEL® Exterior Basecoat		<ul style="list-style-type: none"> › Cement-based, synthetic resin-enhanced basecoat › Colour: grey › Used for basecoating AQUAPANEL® Cement Board Outdoor when finishing with a thin layer of finishing plaster, decorative render or paint 	7.8 (with 5 mm layer thickness)	12	25
		<p style="text-align: right;">Click or scan for datasheet</p> 			
AQUAPANEL® Exterior Basecoat – white		<ul style="list-style-type: none"> › Cement-based, synthetic resin-enhanced basecoat › Colour: white › Used for basecoating AQUAPANEL® Cement Board Outdoor when finishing with a thin layer of finishing plaster, decorative render or paint 	6.3 (with 5 mm layer thickness)	12	25
		<p style="text-align: right;">Click or scan for datasheet</p> 			
SM700 Pro		<ul style="list-style-type: none"> › Mineral basecoat › Fibre-reinforced › Used as a basecoat in External Thermal Insulation Composite Systems (ETICS) – e.g. Knauf WARM WALL Plus › Colour: white (special colours available on request) 	7.0-13.0 (5-10 mm layer thickness)	12	25
Reinforcing mesh				Width (mm)	Roll length (mm)
AQUAPANEL® Reinforcing Mesh		<ul style="list-style-type: none"> › Alkali-resistant coating › Colour: blue › Used to reinforce AQUAPANEL® Exterior Basecoat and AQUAPANEL® Exterior Basecoat – white › Mesh size: 4x4 mm › Initial tear strength: approx. 2,200 N/5 cm › Approx. 160 g/m² 		1,000	50,000
		<p style="text-align: right;">Click or scan for datasheet</p> 			
Armiergewebe 4x4 mm		<ul style="list-style-type: none"> › Alkali-resistant coating › Colour: white with blue markings › Used as a reinforcing mesh in External Thermal Insulation Composite Systems (ETICS) – e.g. Knauf WARM WALL Plus › Mesh size: 4x4 mm › Initial tear strength: approx. 2,000 N/5 cm › Approx. 165 g/m² 		1,000	50,000







Basecoat primer			Coverage (approx kg/m ²)	Storage life (approx month)	Weight (kg/bucket)
AQUAPANEL® Basecoat Primer		<ul style="list-style-type: none"> › Synthetic dispersion › Alkali-resistant › Colour: white › Used as a primer on AQUAPANEL® Exterior Basecoat and AQUAPANEL® Exterior Basecoat – white where AQUAPANEL® render finishes are used › Reduces suction variations 	7.8 (with 5 mm layer thickness)	12	15
			Click or scan for datasheet 		
Finishing renders			Coverage (approx kg/m ²)	Storage life (approx month)	Weight (kg/unit)
AQUAPANEL® Exterior Mineral Finish – white		<ul style="list-style-type: none"> › Mineral finishing render › For use on top of AQUAPANEL® Exterior Basecoat and AQUAPANEL® Exterior Basecoat – white › Grain size: 2 mm › Can be used as a smooth floating finishing render or freely structured using different tools and designs 	3.0 (with 2 mm layer thickness)	12	30
			Click or scan for datasheet 		
AQUAPANEL® Exterior Dispersion Plaster – white		<ul style="list-style-type: none"> › Ready-to-use › Pasty consistency › Water-repellent › Allows diffusion › Prevents fungal attack › For application on AQUAPANEL® Exterior Basecoat and AQUAPANEL® Exterior Basecoat – white › Grain size: 2 mm 	3.1	24	25
			Click or scan for datasheet 		
AQUAPANEL® Exterior Silicon Synthetic Resin Plaster – white		<ul style="list-style-type: none"> › Ready-to-use › Pasty consistency › Water-repellent › Allows diffusion › Prevents fungal attack › For application on AQUAPANEL® Exterior Basecoat and AQUAPANEL® Exterior Basecoat – white › Grain size: 2 mm 	3.1	24	25
			Click or scan for datasheet 		

Interior lining

Knauf Exterior Wall systems include an unrivalled choice of fully compatible lining boards to meet any specification need, including moisture rating, impact resistance, fire rating and sound reduction. For specialist applications in wet and humid areas, AQUAPANEL® Cement Board Indoor has been specifically developed to provide a robust and reliable solution, including in swimming pools and steam saunas. All boards come with comprehensive accessories including vapour control layers, sealant tapes, joint fillers, adhesives and screws.

Vapour barriers			Width (mm)	Roll length (mm)
Knauf Insulation LDS 10 Silk 	<ul style="list-style-type: none"> › Vapour control membrane made of high strength polypropylene spun-bonded fabric › Diffusion equivalent air layer thickness (sd): 10 m › Approx 140 g/m² 	3,000	50,000	
Adhesive tapes			Width (mm)	Roll length (mm)
Trenn-Fix 	<ul style="list-style-type: none"> › Special coated paper strip › Adhesive along one edge › Used as separation strip between dry-built surfaces and other constructional elements › Used between dry-built surfaces to generate a sliding separation 	65	50,000	
Knauf Insulation LDS Soliplan 	<ul style="list-style-type: none"> › One-sided adhesive tape made of kraft paper › Used for durable air-tight bonding of vapour barrier overlaps and fitting edges 	60	40,000	
Knauf Insulation LDS Solitwin 	<ul style="list-style-type: none"> › One-sided reinforced adhesive tape made of low-density polyethylene (LDPE) › With centre-slit backing paper › Used for durable and elastic air-tight bonding of the vapour barrier in corner areas and window connections 	60	25,000	
Knauf Insulation LDS Solifit 	<ul style="list-style-type: none"> › One-sided reinforced adhesive tape made of low-density polyethylene (LDPE) › Used for durable and elastic air-tight bonding of vapour barrier overlaps and penetrations, when flexible connections are necessary (e.g. pipes, beams, etc.) 	60	25,000	
Knauf Insulation LDS Solifit S 	<ul style="list-style-type: none"> › One-sided reinforced adhesive tape made of low-density polyethylene (LDPE) › Used for durable and elastic air-tight bonding of vapour barrier overlaps and penetrations, when flexible connections are necessary (e.g. pipes, beams, etc.) › No peeling, collection and disposal of the release paper required › Easy handling by finger lift › Tape tears by hand 	60	25,000	
Knauf Insulation LDS Kleberaube 	<ul style="list-style-type: none"> › Elastic, double-sided adhesive tape › Used for safe, durable and elastic bonding of the vapour barrier to flanking building parts 	25	8,000	

Liquid adhesive			Capacity (ml)	Storage life (approx month)		
Knauf Insulation LDS Solimur		<ul style="list-style-type: none"> › Elastic, durably strong special adhesive › Used for safe, durable and elastic bonding of the vapour barrier to flanking building parts 	600	24		
			310	24		
Adhesive primer			Coverage (approx m)	Storage life (approx month)		
Knauf Insulation LDS Primer		<ul style="list-style-type: none"> › Dispersion-based adhesive primer › To enhance adhesion of LDS adhesive tapes and LDS Solimur to porous substrates to guarantee a durable adhesive bond 	25-30 (100 mm application width)	18		
Air-tight sleeves			Diameter (mm)	Width (mm)	Length (mm)	
Knauf Insulation LDS Universalman-schette		<ul style="list-style-type: none"> › Multi-purpose sleeve › Two-layer polypropylene spun-bonded fabric › For fast and professional, in particular retrospective, sealing of pipe openings in the vapour barrier 	75-125	400	400	
Knauf Insulation LDS Leitungsman-schette		<ul style="list-style-type: none"> › Cable sleeve › Self-adhesive kraft paper › For professional sealing of cable feed-throughs 	8-12	150	150	
Knauf Insulation LDS Leitungsman-schette 6-fach		<ul style="list-style-type: none"> › Cable sleeve › Non-woven polyethylene › For professional sealing of up to 6 cable feed-throughs 	4-11	230	230	
Gypsum boards			Width (mm)	Length (mm)	Thickness (mm)	Weight (approx kg/m²)
Impregnated Gypsum Board 12.5 mm (GKBI/H2)		<ul style="list-style-type: none"> › Used in all fields of interior works as economic cladding of drywall systems in rooms with a constant relative air humidity of ≤ 70% (e.g. domestic bathrooms) › Impregnated for reduced water absorption › Colour of board liner: green › Non-combustible › Long edges: half-rounded tapered edges › Front edges: cut edges › GKBI according to DIN 18180 › H2 according to EN 520 	1,250	2,000	12.5	9.4
				2,500		
				3,000		
Diamant 12.5 mm (GKFI/DFH2IR)		<ul style="list-style-type: none"> › Used in all fields of interior works as cladding of premium drywall systems with enhanced requirements for sound insulation and fire protection › Impregnated for reduced water absorption › Colour of board liner: blue › Non-combustible › Long edges: half-rounded tapered edges › Front edges: cut edges › GKFI according to DIN 18180 › DFH2IR according to EN 520 	1,250	2,000	12.5	13.0
				2,500		

Gypsum boards			Width (mm)	Length (mm)	Thickness (mm)	Weight (approx kg/m ²)
Diamant X 15 mm (GKFI/DFH2IR)		<ul style="list-style-type: none"> Used in all fields of interior works as cladding of premium drywall systems for optimal statics Impregnated for reduced water absorption Colour of board liner: blue Non-combustible Long edges: half-rounded tapered edges Front edges: cut edges GKFI according to DIN 18180 DFH2IR according to EN 520 	1,250	2,750	15	15.6
Drywall screws					Width (mm)	Length (mm)
Schnellbauschraube TN Feingewinde		<ul style="list-style-type: none"> To fix impregnated gypsum boards (GKBI/H2) to metal substructures Bugle head Nail tip Double, fine-pitched thread Metal thickness ≤ 0.7 mm Incl. one bit/package 	3.5	25	35	
Schnellbauschraube TB		<ul style="list-style-type: none"> To fix impregnated gypsum boards (GKBI/H2) to metal substructures Bugle head Drill tip Metal thickness: 0.7 mm < x ≤ 2.25 mm Incl. one bit/package 	3.5	25	45	
Diamantschraube XTN		<ul style="list-style-type: none"> To fix Diamant boards (GKFI/DFH2IR) to metal and timber substructures Self-tapping thread Nail tip Metal thickness ≤ 0.7 mm and timber constructions (except for XTN 3.9x23 mm) Incl. one bit/package 	3.9	23	33	38
Diamantschraube XTB		<ul style="list-style-type: none"> To fix Diamant boards (GKFI/DFH2IR) to metal substructures Self-tapping thread Drill tip Metal thickness: 0.7 mm < x ≤ 2.25 mm Incl. one bit/package 	3.9	35	55	
Gypsum filler				Coverage (approx. kg/m ²)	Storage life (approx month)	Weight (kg/bag)
Uniflott		<ul style="list-style-type: none"> Gypsum filler for hand filling joints of drywall systems Low drying shrinkage Very high crack resistance Quick drying and hardening Application in interiors for gypsum boards or composite boards with half-rounded edge (HRK) or half-rounded tapered edge (HRAK) without joint tape on paper liner covered edges with a metal stud frame 	0.5	9	5	25

Interior finishing

From primers, renders, skim coatings and paint, Knauf offers a full range of surface finishes for every need – from standard to high-end Q4 specifications with minimal marks, traces or shading caused by shallow light angles. The end result will depend on the decorative finish required as well as the skills of the contractor.

Finishing plaster			Coverage (approx. kg/m ²)	Storage life (approx month)	Weight (kg/bag)
Super Finish		<ul style="list-style-type: none"> Ready-to-use, all-purpose filler Suitable as joint finish (Q2), for full-surface filling (quality grades Q3 and Q4), as well as smoothing numerous substrates 	1.6	12	20

PRODUCT HANDLING

Boards



- › Always carry the boards upright, or use board rollers. Handle with fork lift or crane as palletted goods. Take care not to damage corners and edges when setting the boards down. Place boards down on their long edge before laying them flat.

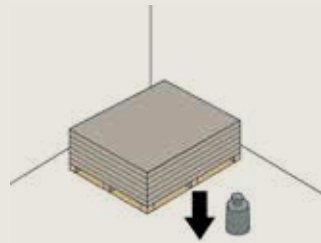

- › Ensure that the base is strong enough to support the boards.



- › Protect boards from moisture and weathering before they are installed. Boards which have become damp must be dried on both sides on a flat surface prior to fitting. Before installing, condition the boards to the ambient temperature and humidity.

Profiles



- › Protect profiles from moisture and weathering before they are installed. Products should not be left permanently exposed to the elements.

Powder materials



- › Store bags in a dry place and in original packaging.

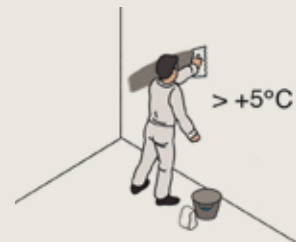

- › Do not apply joint fillers, basecoat or finishing materials in temperatures less than +5°C.

Health and safety

- › Avoid unnecessary dust on job site when using electrical saw. Keep sanding and other dust generation to a minimum. Maintain adequate ventilation and/or wear suitable protection.
- › Exercise care when using power tools and take all necessary precautions.
- › Follow instructions on packaging when applying system accessories.
- › When using powdered products, mix with water in well-ventilated conditions. Avoid contact with eyes and skin. In the event of contact with the eyes, irrigate with plenty of clean water immediately.
- › When handling insulation or cutting boards which contain glassfibre, wear suitable protection including face mask and gloves. Wear protective glasses when working overhead.
- › Follow national health and safety regulations at all times.

Product data sheets and material safety data sheets are available on our website www.AQUAPANEL.com/downloads.

Insulation

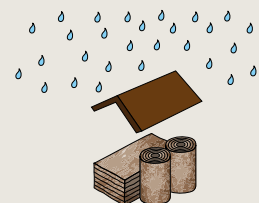

- › Insulation materials are supplied enclosed in packaging which is designed for short term protection only. For longer term protection on site, the product should be stored either indoors, or under cover and off the ground. Products should not be left permanently exposed to the elements.

FURTHER INFORMATION

Plaster profile overview

The profile overview represents a selection of applicable plaster profiles for Knauf Exterior Wall with AQUAPANEL® Technology. It shows areas of application, product names and material numbers of Knauf profiles and other selected manufacturers.

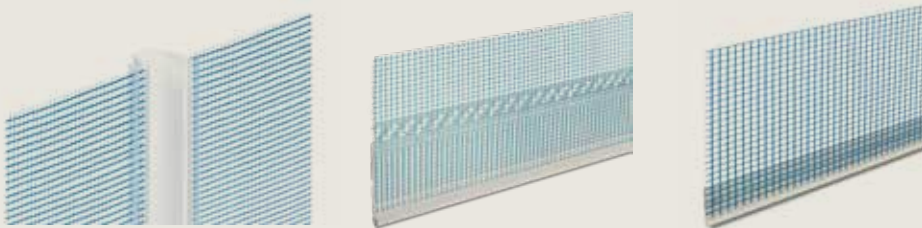

Click or scan to get more information



Seismic performance

Knauf Exterior Wall with AQUAPANEL® Technology is ideal for earthquake zones because of its low dead weight. Lightweight structures have a lower risk of failure and less potential for damage in the case of failure. In the event of an earthquake, redevelopment and repair can easily be carried out.

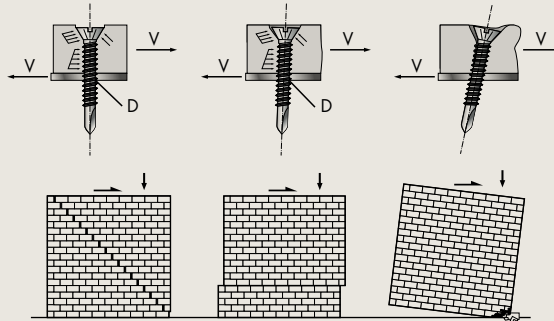

Click or scan to get more information



Fasteners and penetrations

Knauf Exterior Wall with AQUAPANEL® Technology can be penetrated by fasteners, pipe penetrations or electrical cable installations on the interior as well as on the exterior stud frame of the wall construction. For further information, please refer to the corresponding instructions.



Click or scan to get more information



References

A selection of worldwide references of Knauf Exterior Wall with AQUAPANEL® Technology as well as details on individual projects can be found on our website. Here you will find the latest inspirations for your next construction project.



Click or scan to get more information



BENEFIT FROM THE VALUABLE SERVICES FROM AQUAPANEL®



AQUAPANEL® WEBSITE

Discover a world of online resources and support available 24/7 to help you understand and communicate the full scope of the AQUAPANEL® family. Find and download up to date in-depth technical documents, videos and the latest materials.

› www.aquapanel.com



INTERNATIONAL TRAINING CENTRE

Stay in the loop and keep your knowledge at the cutting edge with professional, practical seminars from the AQUAPANEL® International Training Centre. With courses designed to give you and your people fresh insights and understanding you get a unique advantage. For more information, please contact your local AQUAPANEL® partner or email us:

› aquapanel.info@knauf.com



YOUTUBE CHANNEL

See AQUAPANEL® in action. Our YouTube channel features product introductions and how-to videos on everything from installation to finishing options and curved wall constructions. It's all available any time – and we'll be regularly updating the channel with our latest videos, making it the first place to go for new AQUAPANEL® content.

› www.youtube.com
Search: Knauf Aquapanel

All technical changes reserved. Only the current printed instructions are valid. Our warranty is expressly limited to our products in flawless condition. The constructional and structural properties and characteristic building physics of Knauf systems can solely be ensured with the exclusive use of Knauf system components, or other products expressly recommended by Knauf. All application quantities and delivery amounts are based on empirical data that are not easily transferable to other deviating areas. All rights reserved. All amendments, reprints and photocopies, including those of excerpts, require the express permission of Knauf Aquapanel GmbH & Co. KG, Zur Helle 11, 58638 Iserlohn, Germany. AQUAPANEL® is a registered trademark.

Knauf Aquapanel GmbH & Co. KG
Zur Helle 11
58638 Iserlohn
Germany